

Medical Way

di Roberto Spano



BONTEMPI.
PASSIONE ITALIANA, QUALITÀ TEDESCA

BONTEMPI®

Zahnärztliche Chirurgie / Dental Surgery / Chirurgia dentale / Cirurgia dental / Chirurgie dentaire
CATALOGO RIDOTTO A CIRCA IL 15% DEL POTENZIALE DI ASSORTIMENTO

*La Medical Way è un'azienda
nata con l'intento*

*di mettere in contatto i produttori con i clienti finali
evitando passaggi a volte inutili e dispendiosi.*

*Il 90% dei prodotti trattati
vengono direttamente
dai produttori mantenendo
una qualità costante
ed una rapida ed efficace consulenza tecnica
in caso di necessità.*

Roberto Spano

Medical Way

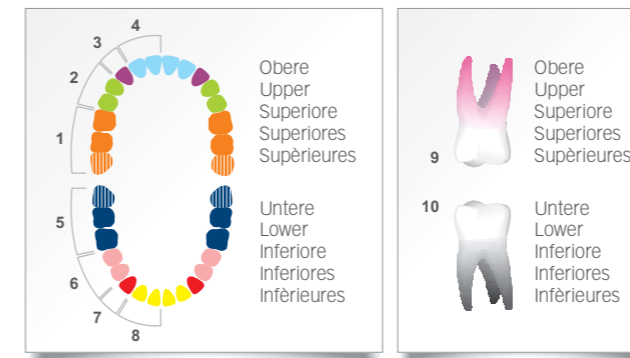

Zahnzangen
Extracting Forceps
Pinze da estrazione
Pinzas da extracciòn
Daviers

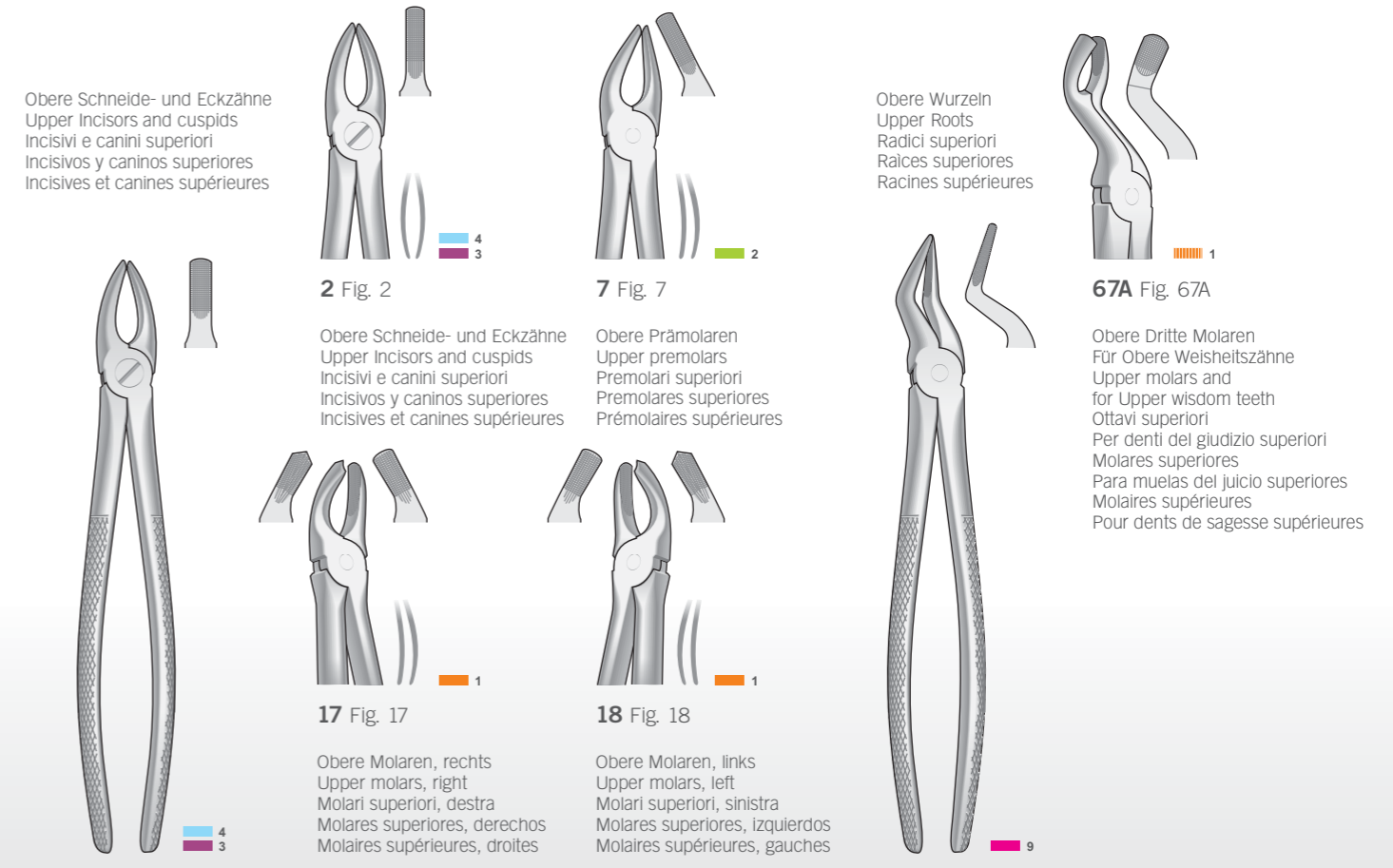

1
Fig. 1

51A
Fig. 51A



Zahnzangen
Extracting Forceps
Pinze da estrazione
Pinzas da extracciòn
Daviers

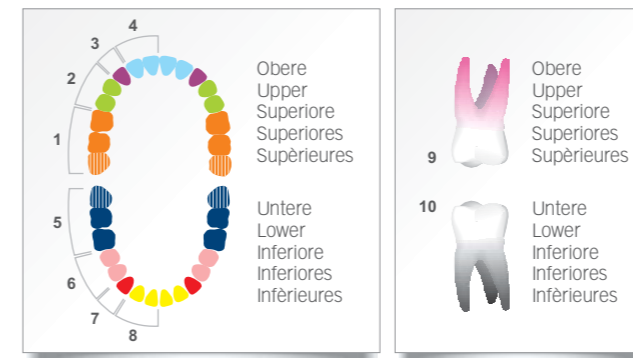
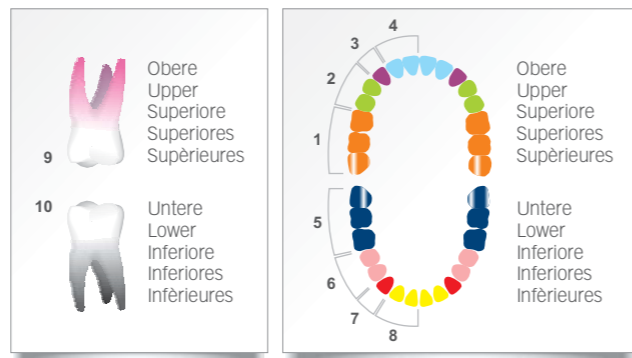

Kinderzahnzangen
Extracting Forceps for children
Pinze da estrazione per bambini
Forceps dentales para niños
Daviers pour enfants



Untere Eckzähne und Prämolaren
Lower cuspids and premolars
Canini e premolari inferiori
Caninos y premolares inferiores
Canines et prémolaires inférieures

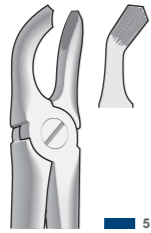

79 Fig. 79

Untere Weisheitszähne
Lower wisdom teeth
Denti del giudizio inferiori
Muelas del juicio inferiores
Dent de sagesse inférieures

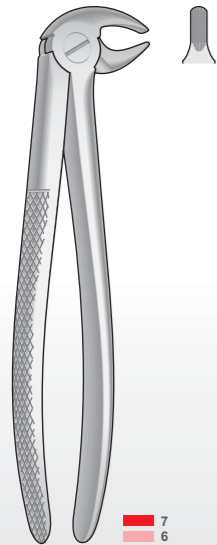

13 Fig. 13

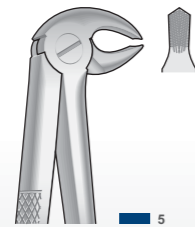

22 Fig. 22

Untere Molaren
Lower molars
Molari inferiori
Molares inferiores
Molaires inférieures

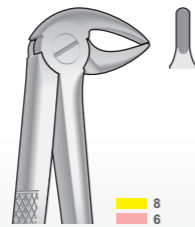

33 Fig. 33

Untere Prämolaren, Schneidezähne und Wurzeln
Lower incisors, premolars and roots
Incisivi, premolari e radici inferiori
Incisivos, premolares y raíces inferiores
Incisives, prémolaires et racines inférieures

Untere Wurzeln
Lower roots
Radici inferiori
Raíces inferiores
Racines inférieures

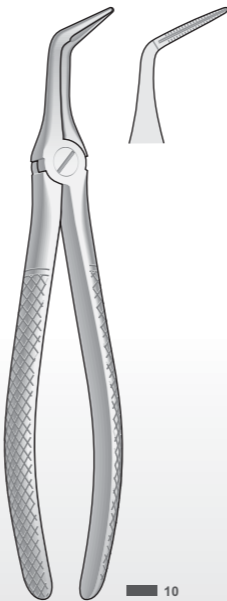

46L Fig. 46L

Obere Molaren
Upper molars
Molari superiori
Molares superiores
Molaires supérieures

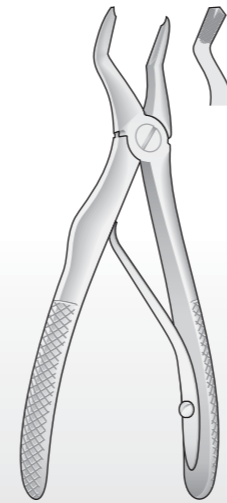

PEB-3 Fig. 3

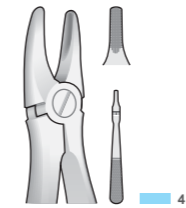

PEB-1 Fig. 1

Obere Schneidezähne
Upper incisors
Incisivi superiori
Incisivos superiores
Incisives supérieures

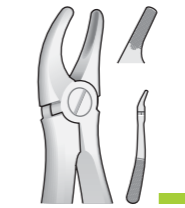

PEB-2 Fig. 2

Obere Prämolaren
Upper premolars
Premolari superiori
Premolares superiores
Prémolaires supérieures

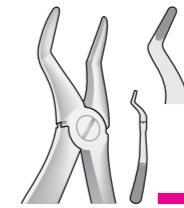

PEB-4 Fig. 4

Obere Wurzeln
Upper roots
Radici superiori
Raíces superiores
Racines supérieures



PEB-5 Fig. 5

Untere Schneidezähne
Lower incisors
Incisivi inferiori
Incisivos inferiores
Incisives inférieures



PEB-6 Fig. 6

Untere Molaren
Lower molars
Molari inferiori
Molares inferiores
Molaires inférieures

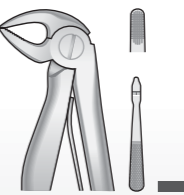

PEB-7 Fig. 7

Untere Wurzeln
Lower roots
Radici inferiori
Raíces inferiores
Racines inférieures

Untere Molaren und Weisheitszähne
Lower molars and wisdom teeth
Denti del giudizio e molari inferiori
Muelas del juicio y molares inferiores
Dent de sagesse et molaires inférieures

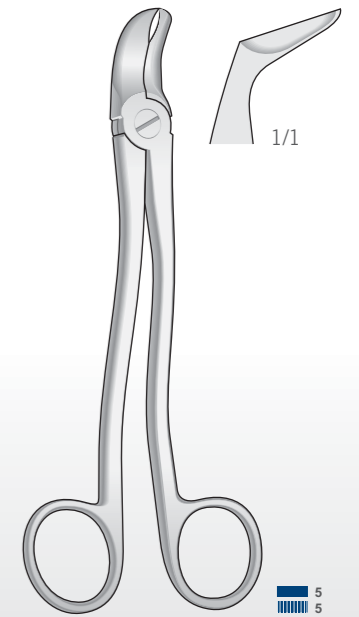

RO-1 Fig. 175 mm



Zahnzangen mit Paßformgriff
 Extracting Forceps with anatomically shaped handle
 Pinze per estrazione con manico anatomico
 Pinzas da extracción mango adaptado a la anatomía de la mano
 Daviers avec manche adapté à l'anatomie de la main

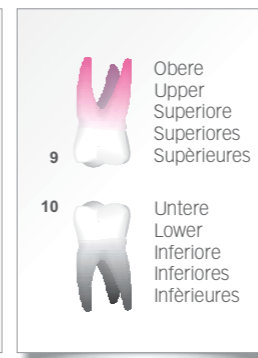
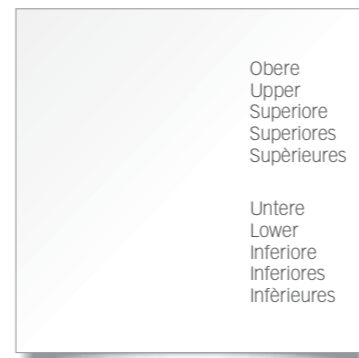
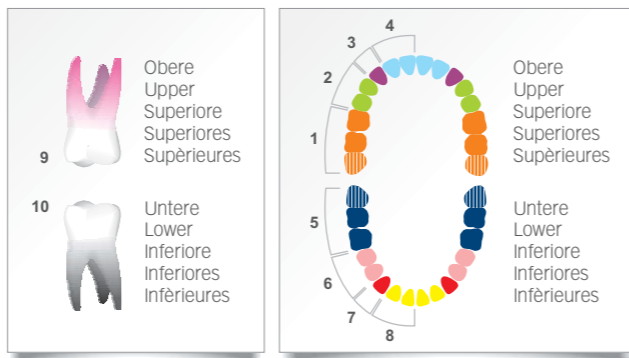

Zahnzangen
 Extracting Forceps
 Pinze da estrazione
 Pinzas da extracción
 Daviers



Obere Schneide- und Eckzähne
 Upper incisors and cuspids
 Incisivi e canini superiori
 Incisivos y caninos superiores
 Incisives et canines supérieures

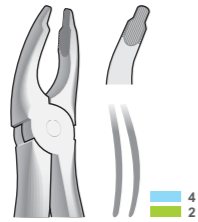

S-35 Fig. 35

Obere Schneidezähne und Prämolaren, tiefgreifend
 Upper incisors and bicuspids, deep-gripping
 Incisivi e premolari superiori, presa in profondità
 Incisivos y premolares superiores, a gran calado
 Incisives et prémolaires supérieures, à attaque profonde

Untere Wurzeln Schneide- und Eckzähne
 Lower roots, incisors and cuspids
 Radici, incisivi e canini inferiori
 Raíces, incisivos y caninos inferiores
 Racines, incisives et canines inférieures

Untere Weisheitszähne
 Lower wisdom teeth
 Denti del giudizio inferiori
 Muelas del juicio inferiores
 Dent de sagesse inférieures

Obere Schneide- und Eckzähne
 Upper incisors and cuspids
 Incisivi e canini superiori
 Incisivos y caninos superiores
 Incisives et canines supérieures

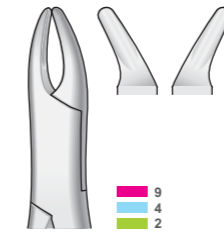

CRYER AM-150 Fig. 150

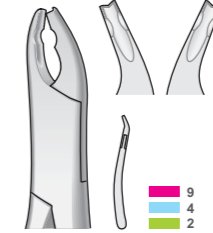

AM-150X Fig. 150AS

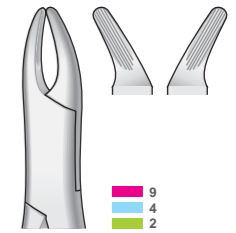

AMG-150X Fig. 150

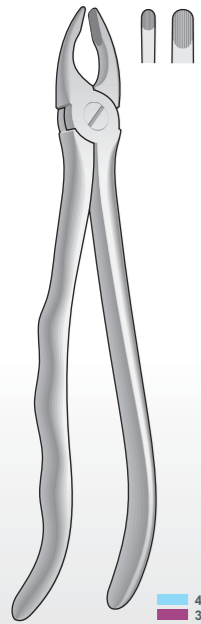

S-3AN
Fig. 3

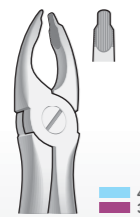

S-34 Fig. 34

Obere Schneide- und Eckzähne
 Upper incisors and cuspids
 Incisivi e canini superiori
 Incisivos y caninos superiores
 Incisives et canines supérieures

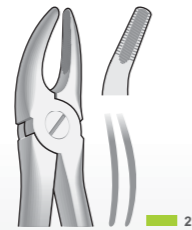

S-7 Fig. 7

Obere Prämolaren
 Upper premolars
 Premolari superiori
 Premolares superiores
 Prémolaires supérieures

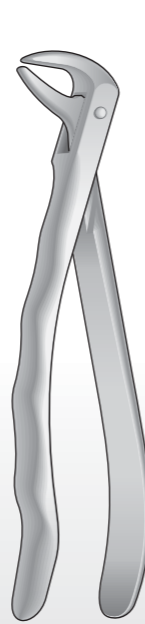

I-36
Fig. 36

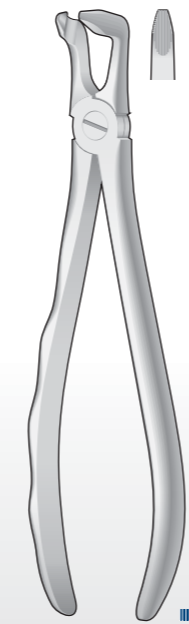

I-79N
Fig. 79N



AM-1
Fig. 1

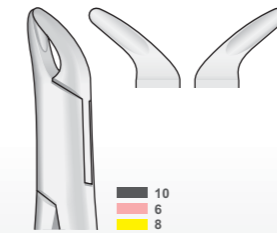

CRYER AM-151 Fig. 151

Untere Schneidezähne, Prämolaren, Wurzeln
 Lower incisors, premolars, roots
 Incisivi, premolari, radici inferiori
 Incisivos, premolares, raíces inferiores
 Incisives, prémolaires, racines inférieures

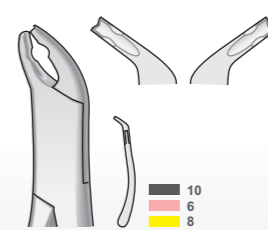

AM-151X Fig. 151AS

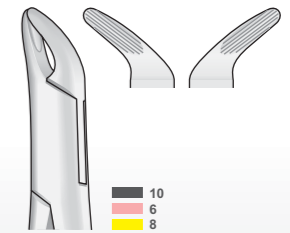

AMG-151X Fig. 151



Wurzelfragmentinstrumente
 Fragment Forceps
 Strumenti per frammenti di radici
 Instrumentos para fragmento de raíces
 Instruments pour fragments de racines

Sonden - Periotome
 Probes - Periostomes
 Sonde - Periostotomi
 Sondes - Periostòtomos
 Sondas - Périotomes

Diamantiert
 With Diamond tip
 Con punta diamantata
 Diamantada
 Diamantées

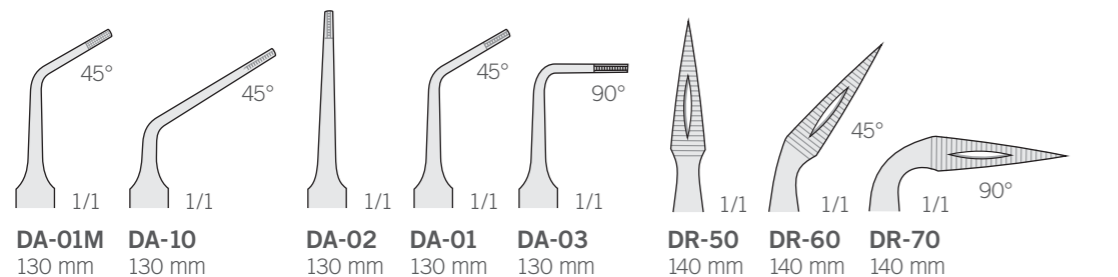

Diamantiert
 With Diamond tip
 Con punta diamantata
 Diamantada
 Diamantées

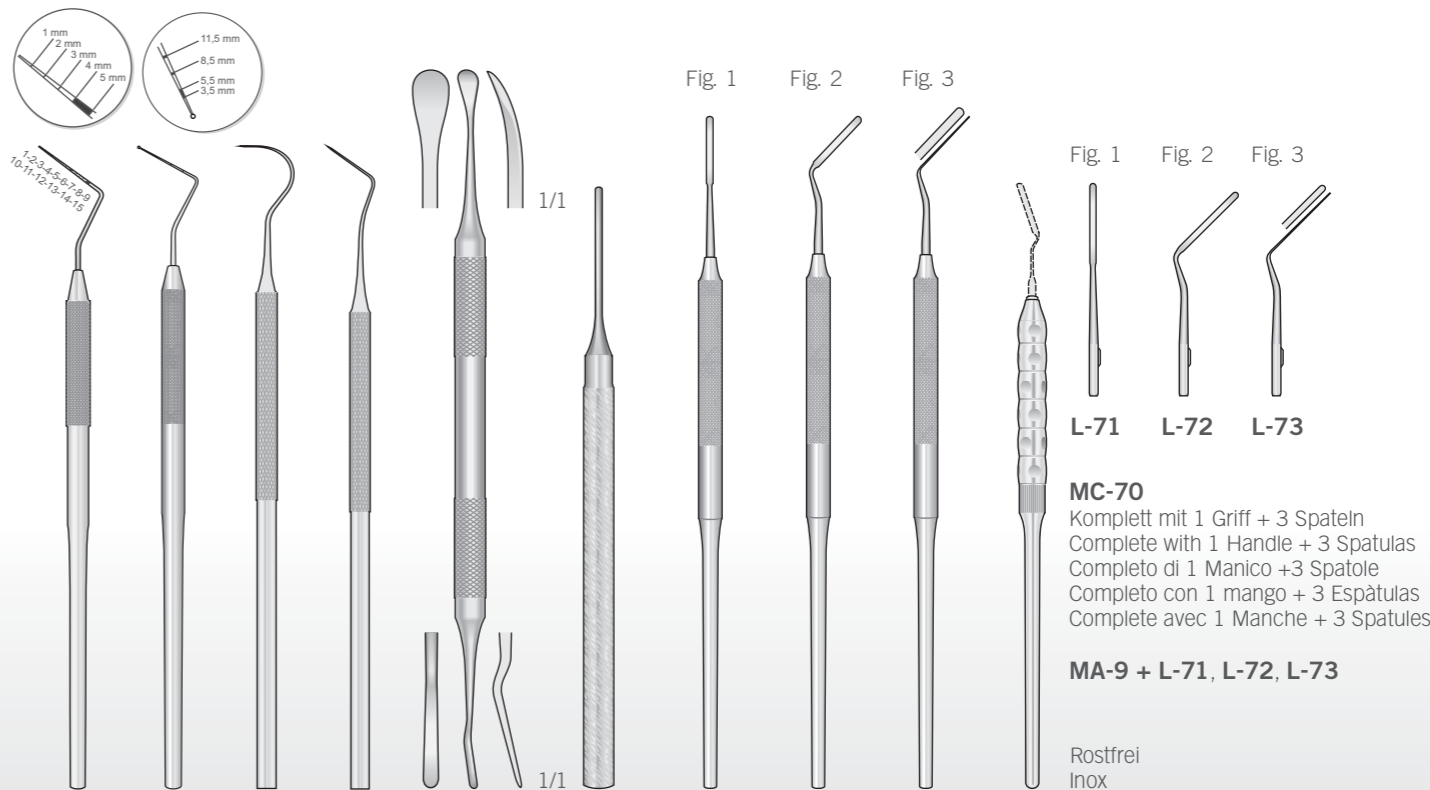
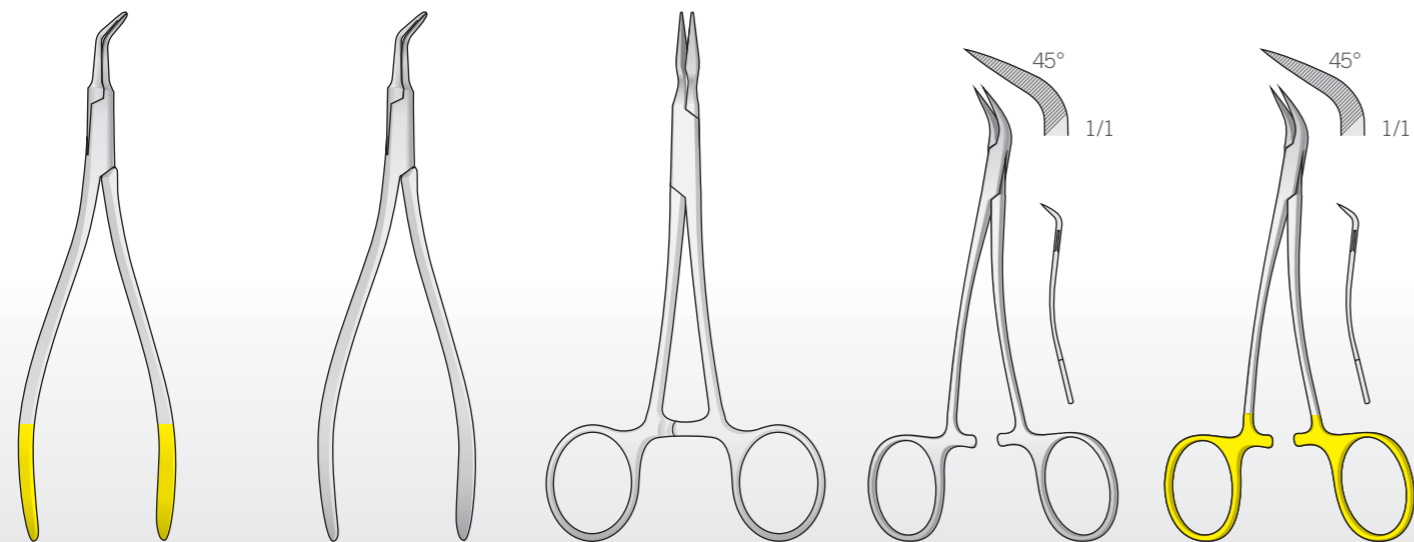

DA-01M/DA-10
130 mm

DA-01/DA-03
130 mm

STIEGLITZ
DR-50/DR-60
140 mm

PEET
DR-40
120 mm

PEET
DR-40M
120 mm

CP-15UNC
SM-15
160 mm

WHO
SM-21
160 mm

SO-1
Fig. 23

SO-4
Fig. 9

MIR-08
175 mm

MIR-09
140 mm

MC-11
160 mm

MC-12
160 mm

MC-13
160 mm

MA-9
140 mm

L-71
L-72
L-73

MC-70
 Komplett mit 1 Griff + 3 Spateln
 Complete with 1 Handle + 3 Spatulas
 Completo di 1 Manico + 3 Spatole
 Completo con 1 mango + 3 Espátulas
 Complete avec 1 Manche + 3 Spatules

MA-9 + L-71, L-72, L-73

Rostfrei
Inox



Wurzelheber
Root Elevators
Leve per radici
Elevadores para raíces
Elévateurs à racines



Wurzelheber
Root Elevators
Leve per radici
Elevadores para raíces
Elévateurs à racines

Eine seite gezahnt - One side serrated
Un lato dentellato - Dentadura más lado
Dentelure sur un côté

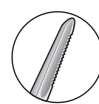

Fig. 94



DL-76
155 mm



Fig. 95



DL-77
155 mm

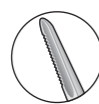

Fig. 100L



DL-78
155 mm



Fig. 100R



DL-79
155 mm

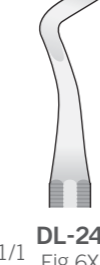

DL-24
Fig.6X



DL-25
Fig.7X

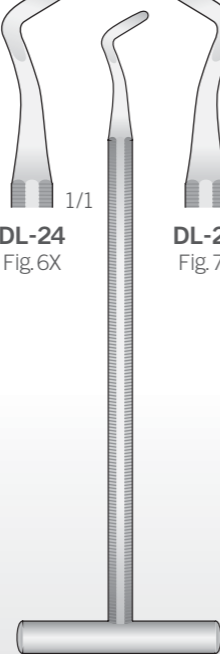

POTT
DL-24/DL-25
155 mm

1,5 mm

2,0 mm

2,5 mm



HEIDBRINK
725-1/2
195 mm



HEIDBRINK
725-3/4
195 mm



HEIDBRINK
725-5/6
195 mm



FAHRENKRUG
DL-05/DL-06
190 mm



DL-05
2,2 mm



DL-06
3,0 mm



DL-102 2,0 mm
DL-103 3,0 mm
DL-104 4,0 mm
DL-105 5,0 mm



DL-81 2,0 mm
DL-82 2,5 mm
DL-83 3,0 mm
DL-84 3,5 mm
DL-85 4,0 mm
DL-86 4,5 mm
DL-87 5,0 mm

DL-81/DL-105
150 mm



DL-112 2,0 mm
DL-113 3,0 mm
DL-114 4,0 mm
DL-115 5,0 mm



DL-91 2,0 mm
DL-92 2,5 mm
DL-93 3,0 mm
DL-94 3,5 mm
DL-95 4,0 mm
DL-96 4,5 mm
DL-97 5,0 mm

DL-91/DL-115
150 mm



BERNARD
DL-73/DL-124
150 mm

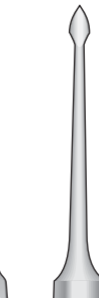

BERNARD
DL-75
140 mm



BERNARD
DL-74
140 mm



BERNARD
DL-123
150 mm

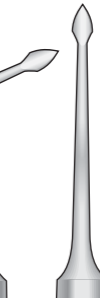

BERNARD
DL-124
150 mm

Gerade
Straight
Diritto
Rectas
Droites

Rechts
Right
Destro
Derecha
À droite

Links
Left
Sinistra
Izquierda
À gauche

Bajonett
Bayonet
Baionetta
Baioneta
Baionnette

Syndesmotome
Syndesmotomes
Sindesmotomi
Syndesmòtomos
Syndesmotomes

3 mm

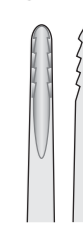

BEIN-2Z
155 mm

4 mm

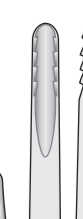

BEIN-4Z
155 mm



Wurzelheber
Root Elevators
Leve per radici
Elevadores para raices
Elévateurs à racines

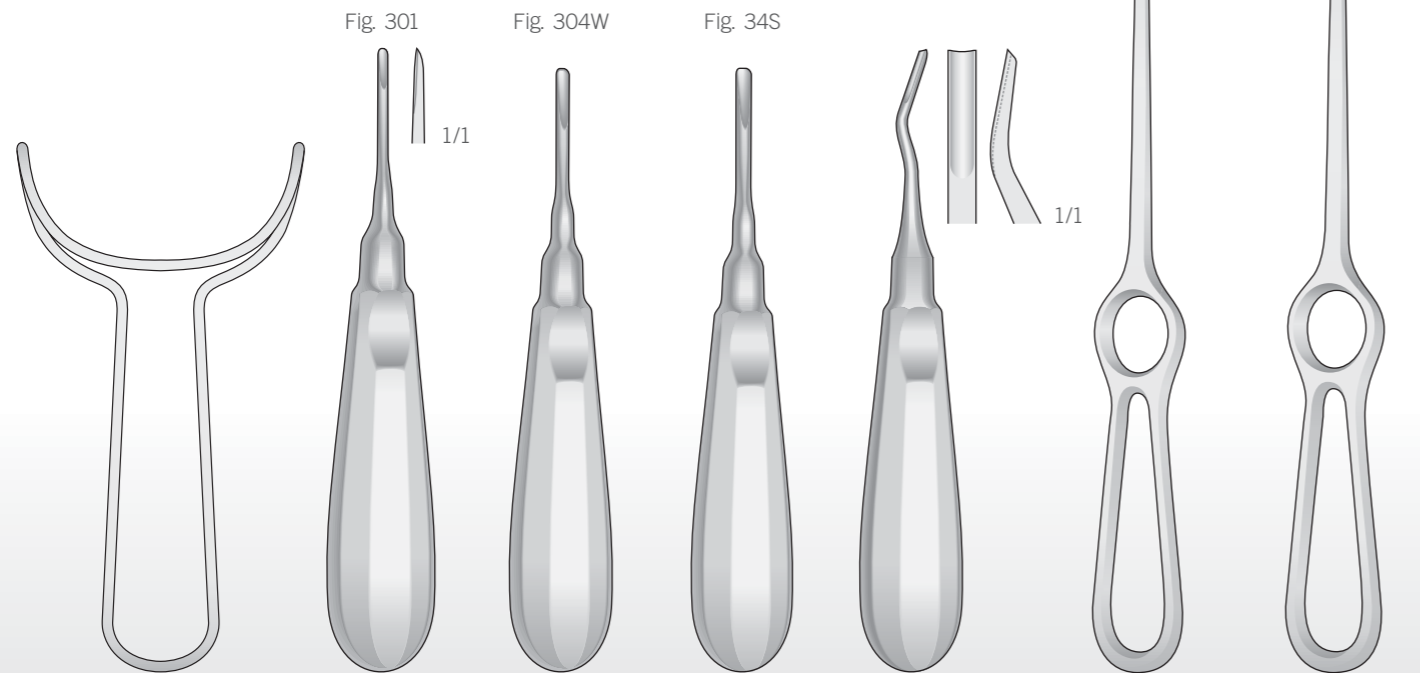
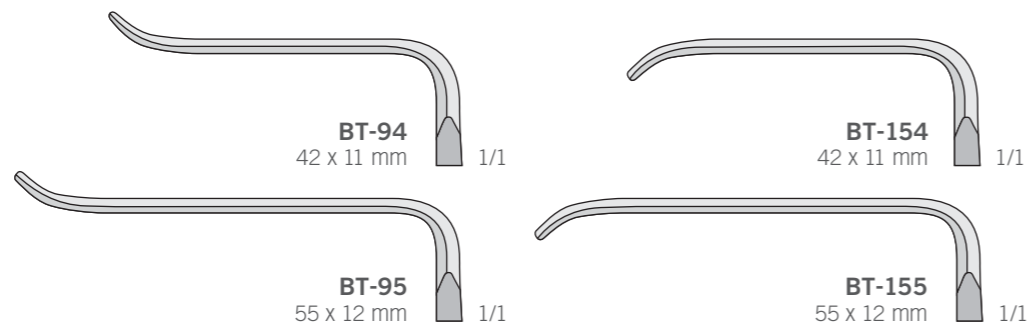

OM-90
150 mm

APEXO DL-34
160 mm

SELDIN DL-48
155 mm

SELDIN DL-49
155 mm

DL-54
160 mm

OBWEGESER BT-154/BT-155
220 mm

OBWEGESER BT-92/BT-100
220 mm



Eine Seite gezahnt
Single serrated cutting edge
Una lama dentata
Una hoja dentada
Une lame dentelée

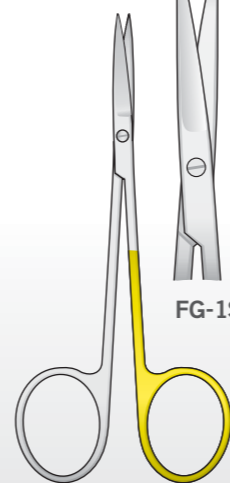
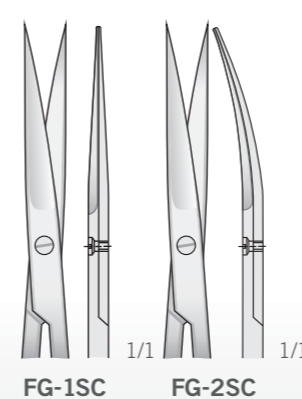
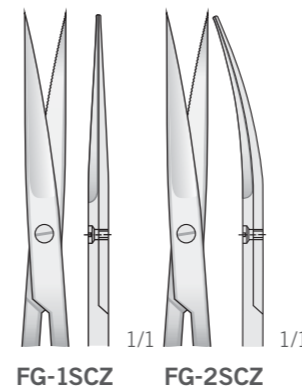

FG-1SC/FG-2SCZ
110 mm

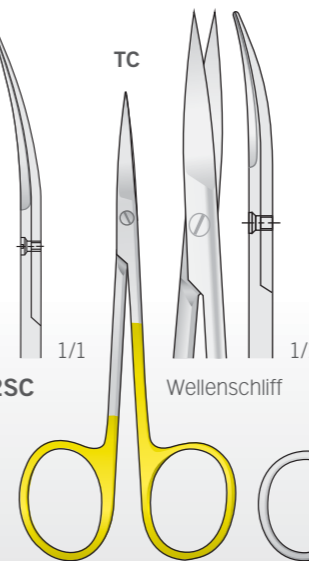

IRIS FM-100
110 mm

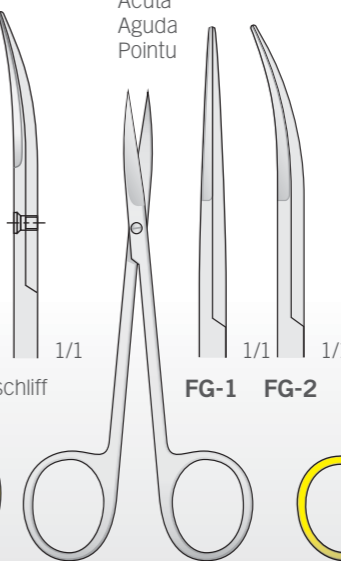

IRIS FG-1/FG-2
110 mm

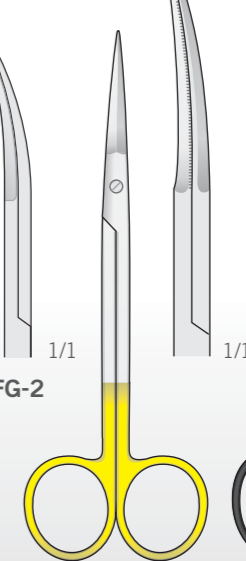

PECK-JOSEPH FG-92
140 mm

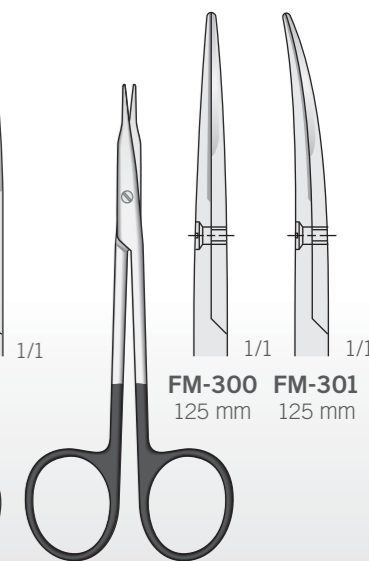

STEVENS FM-300/FM-301
125 mm

Super Cut
Mit einer Schneide gezahnt
With one blade serrated
Con una lama dentellata
Con una hoja dentada
Avec une lame dentelée

Spitz Gezahnt
Sharp Serrated
Acuta Dentellate
Aguda Dentadas
Pointu Dentelé

Chirurgische Scheren
Operating Scissors
Forbici Chirurgiche
Tijeras para cirugía
Ciseaux chirurgicaux





Chirurgische Scheren
Operating Scissors
Forbici Chirurgiche
Tijeras para cirugia
Ciseaux chirurgicaux

Spitz
Sharp
Acuta
Aguda
Pointu

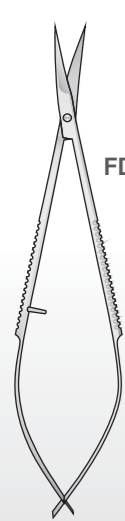

NOYES
FD-10/FD-12
120 mm

Gezahnt
Serrated
Dentellata
Dentadas
Dentelé

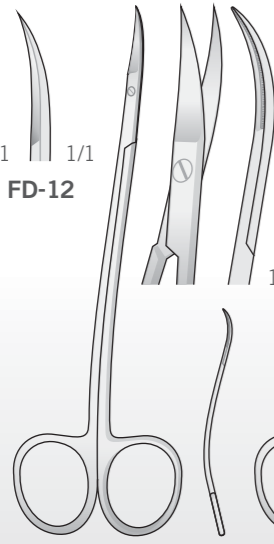

LA GRANGE
LG-1
115 mm

Gezahnt
Serrated
Dentellata
Dentadas
Dentelé

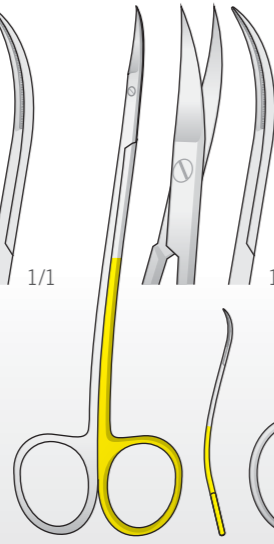

LA GRANGE
LG-1SC
115 mm

Gezahnt
Serrated
Dentellata
Dentadas
Dentelé

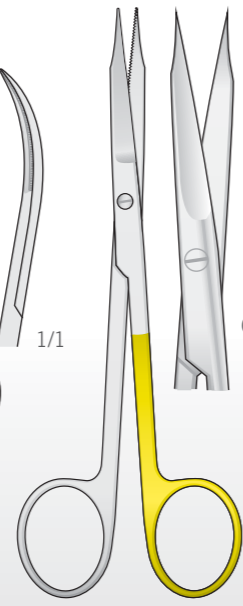

GOLDMAN-FOX
GFR-SC/GFC-SC
135 mm

Gezahnt
Serrated
Dentellata
Dentadas
Dentelé

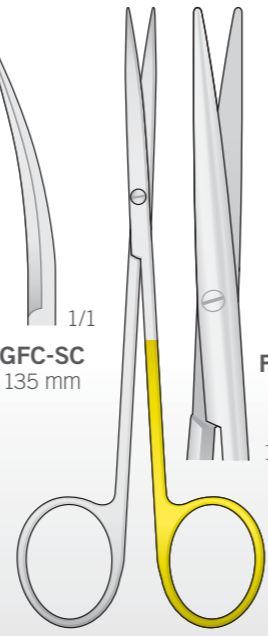

METZENBAUM
FM-1SC/FM-2SC
145 mm

FD-10 FD-12

1/1

1/1

1/1

1/1

GFR-SC GFC-SC
135 mm 135 mm
1/1

FM-1SC FM-2SC
1/1

MF-101
180 mm

MF-103
180 mm

MF-102
180 mm

MF-104
180 mm

Papier Pinzette
Paper Forceps
Pinza per carta
Pince pour papier

6x6 Zähne
6x6 Teeth
6x6 Denti
6x6 Dientes
6x6 Dents



MILLER
DR-78
145 mm



ADSON
BD-30/BD-31
120 mm

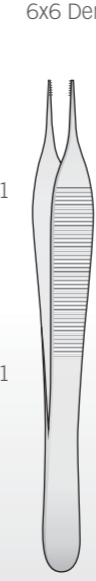

ADSON-BROWN
BD-92
120 mm



KÜHNE
ES-44
105 mm



BD-941/BD-942
125 mm



BD-57/BD-58
100 mm



DE BAKEY
BD-80/BD-82
160 mm

2 mm
BD-82
1/1

2 mm
BD-80
1/1

Chirurgische Pinzetten
Tissue Forceps
Pinzette Chirurgiche
Pinzas quirúrgicas
Pincas chirurgicaux





Chirurgische Pinzetten
Tissue Forceps
Pinzette Chirurgiche
Pinzas quirúrgicas
Pincas chirurgicaux



Nadelhalter
Needle Holders
Port'aghi
Portaagujas
Porte Aiguilles

Empfohlen für Nahtmaterial - Recommended for suture material
Raccomandato per materiale di sutura - Recomendado para sutura
Recommandé pour matériel de suture

R	Standard - Regular - Regolare Regular - Regulaire 2.0, 3.0, 4.0	F	Fein - Fine - Fine Fino - Fin 3.0, 4.0, 5.0, 6.0
M	Mikro - Micro - Micro Micro - Micro 6.0, 7.0, 8.0, 9.0	S	Glatt - Smooth - Liscia Lisa - Lisse 7.0, 8.0, 9.0, 10.0

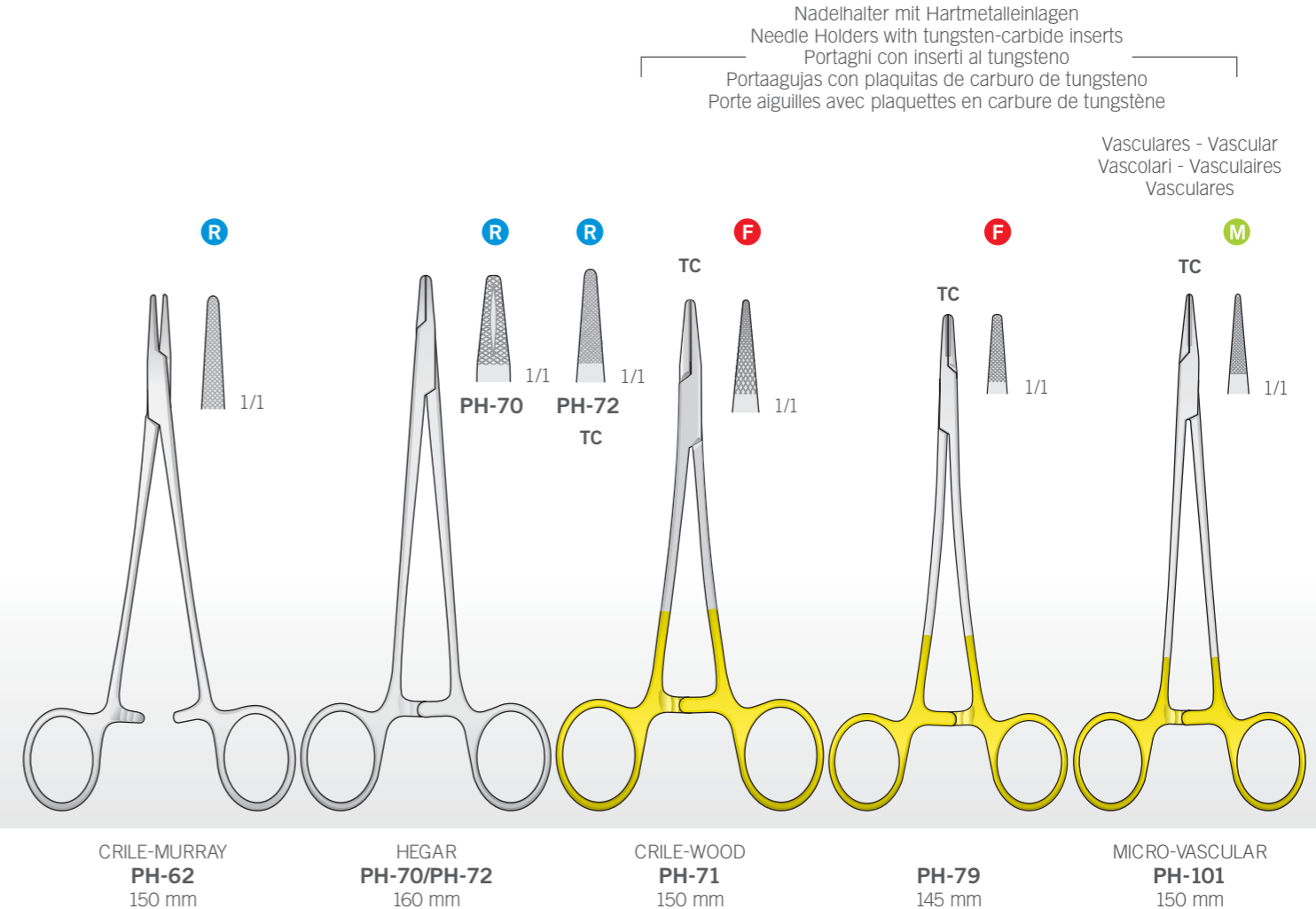
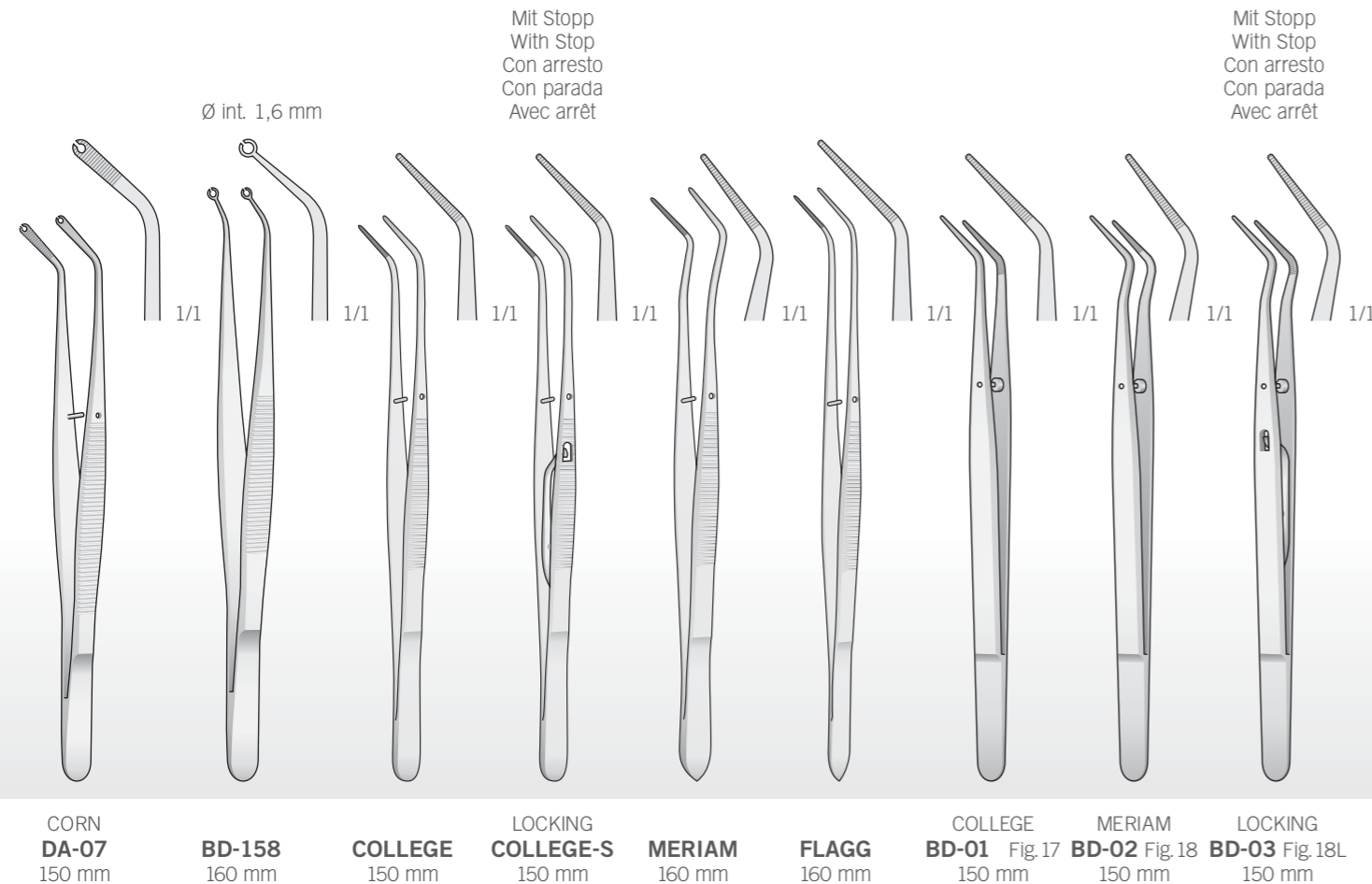



Nadelhalter
Needle Holders
Port'aghi
Portaagujas
Porte Aiguilles

Empfohlen für Nahtmaterial - Recommended for suture material
Raccomandato per materiale di sutura - Recomendado para sutura
Recommandé pour matériel de suture

R 	Standard - Regular - Regolare Regular - Regulaire 2.0, 3.0, 4.0	F 	Fein - Fine - Fine Fino - Fin 3.0, 4.0, 5.0, 6.0
M 	Mikro - Micro - Micro Micro - Micro 6.0, 7.0, 8.0, 9.0	S 	Glatt - Smooth - Liscia Lisa - Lisse 7.0, 8.0, 9.0, 10.0

Nadelhalter mit Hartmetalleinlagen
Needle Holders with tungsten-carbide inserts
Portaghi con inserti al tungsteno
Portaagujas con plaquitas de carburo de tungsteno
Porte aiguilles avec plaquettes en carbure de tungstène

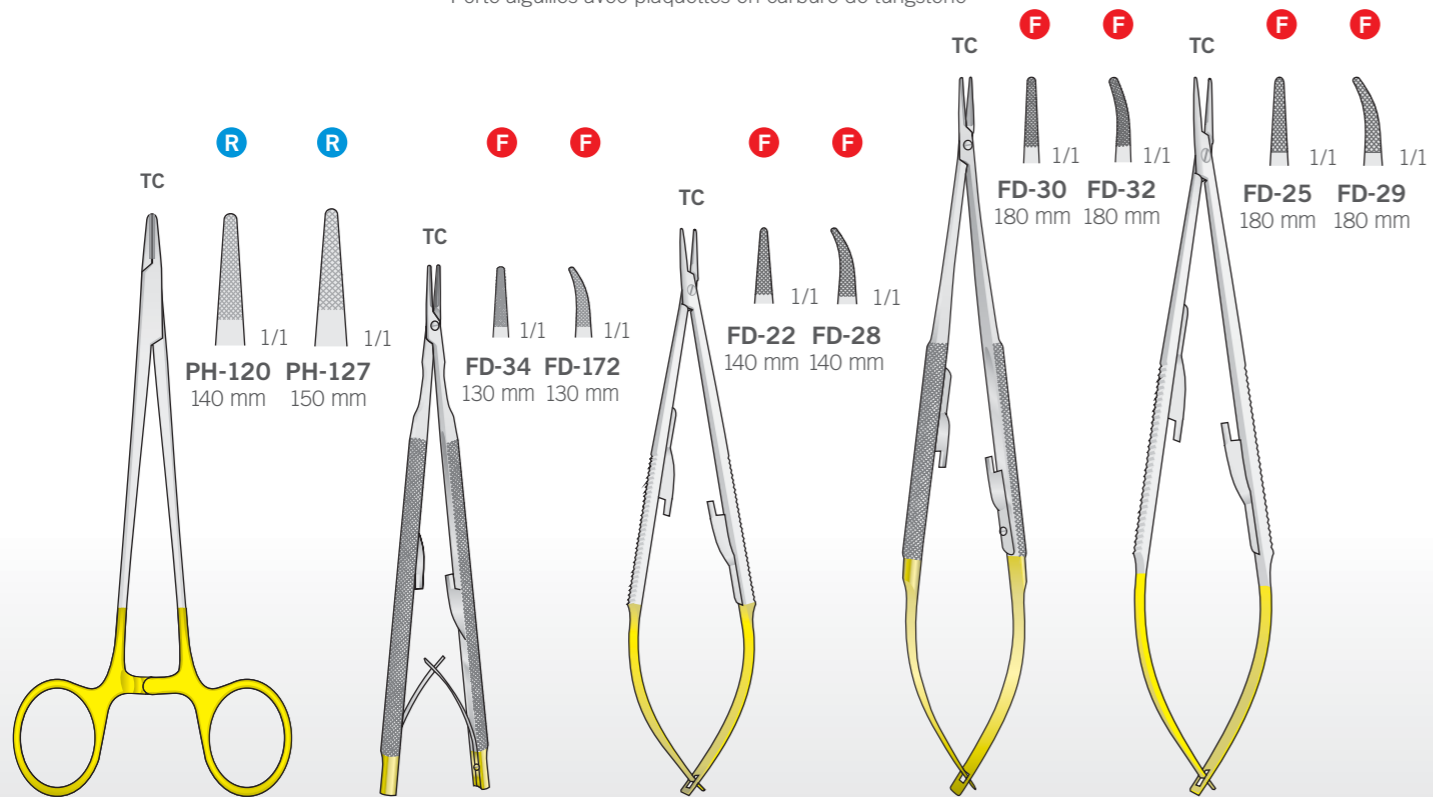

MAYO-HEGAR
PH-120/PH-127

CASTROVIEJO
FD-34/FD-172
130 mm

CASTROVIEJO
FD-22/FD-28
140 mm

JACOBSON
FD-30/FD-32
180 mm

CASTROVIEJO
FD-25/FD-29
180 mm

Kofferdam Instrumente
Rubber-dam Instruments
Strumenti per diga
Instrumentos para dique de goma
Instruments pour digue à caoutchouc

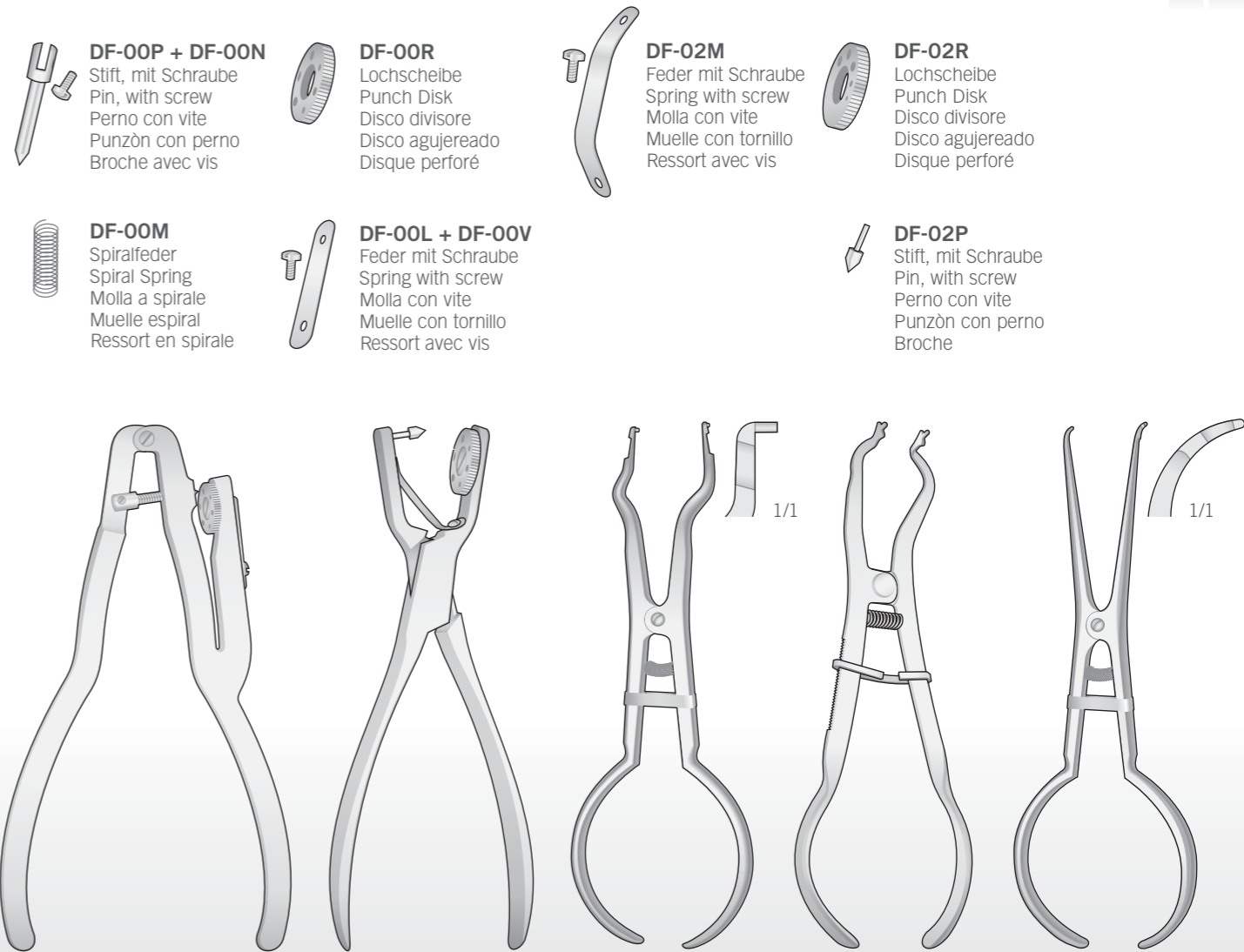

IVORY
DF-00
160 mm

AINSWORTH
DF-02
160 mm

BREWER
DF-10
170 mm

IVORY
DF-12
170 mm

PALMER
DF-15
170 mm



Mundspiegel und Griffe
Mirrors and Mirror handles
Manici e Specchiotti
Espejos y mango
Miroirs et manche

Pack. 12 pcs.

P-3	18 mm
P-4	22 mm
P-5	24 mm

Flach
Plane
Piano
Planos
Plans



Pack. 12 pcs.

RH-4	22 mm
RH-5	24 mm

Rhodiumspiegel
Rhodium Mirror
Specchietto rodiato
Espejo de rodio
Miroir au rhodium

Pack. 6 pcs.

RH-14	22 mm
--------------	-------

MEGA DUO
RHODIUM n.4

Beidseitig Rhodium Beschichtet
Rhodium-coated, both sides
Con rivestimento in rodio su entrambi i lati
Ambos lados con revestimiento de rodio
Revêtu de rhodium des deux côtés



MA-1
120 mm

MA-2
125 mm

MA-7
135 mm

LS-08
100 mm

LS-09
200 mm



Massiv
Solid
Pieno
Sólido
Massif

Massiv
Solid
Pieno
Sólido
Massif

Hohl
Hollow
Vuoto
Hueco
Creux

Rostfrei
Stainless
Inox
Inoxidable
Inoxydable

Rostfrei
Stainless
Inox
Inoxidable
Inoxydable

Rostfrei
Stainless
Inox
Inoxidable
Inoxydable

Skalpellogriff für Mikro-Klingen
Scalpel handle for Micro blades
Manico per micro lame
Mango de bisturí para micro hojas
Manche de bistouris pour micro lames

Micro-Klingen
Micro blades
Micro lame
Micro hojas
Micro lames

Set 10 pcs.

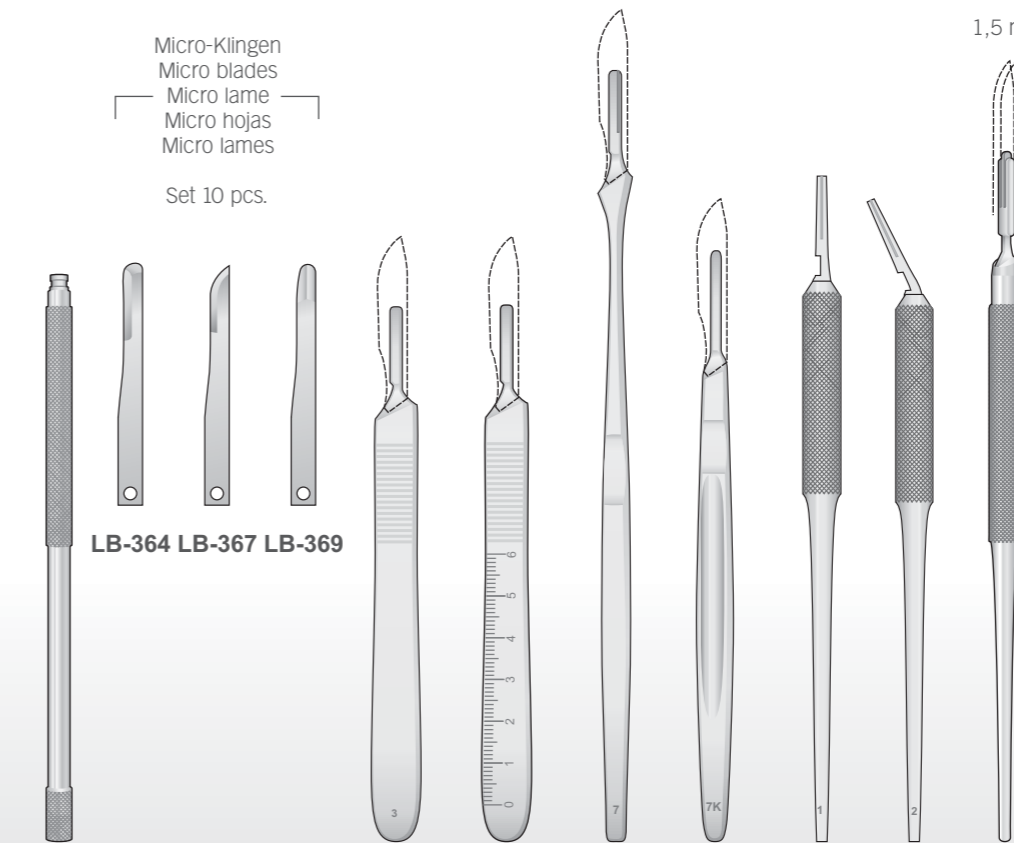

BB-46
135 mm

MA-B3 **MA-B3M**
Fig. 3M

MA-B7 **MA-B7K**

MA-B1 **MA-B2** **MA-B8**
Fig. 5 Fig. 5A 155 mm

Doppelt
Double Blade
Doppia lama
Doble hojas
Double-lames

Packungen à 100
Packages of 100 ea
Scatole da 100 pezzi
Cajas de 100 c/u
Boîtes de 100 pièces

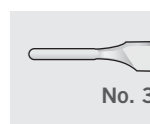

No. 3

1,5 mm

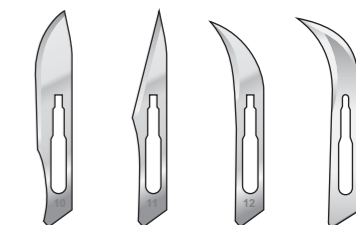

LB-10 **LB-11** **LB-12** **LB-12D**
Fig. 10 Fig. 11 Fig. 12 Fig. 12D

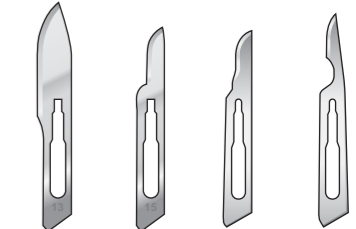

LB-13 **LB-15** **LB-15A** **LB-15C**
Fig. 13 Fig. 15 Fig. 15A Fig. 15C

Scharf
Sharp
Tagliente
Tranchant
Cortante



HB

Stumpf
Blunt
Smusso
Mousse
Romo



ES-27

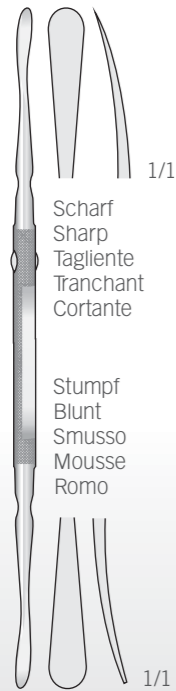

FREER

180 mm



MOLT
MO-8
185 mm

Fig. 2/4

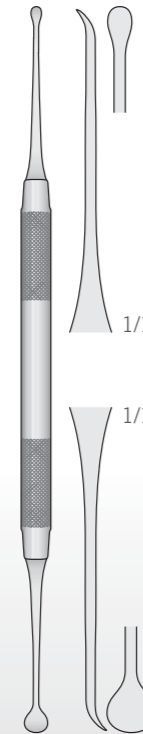

MOLT
MO-10
195 mm

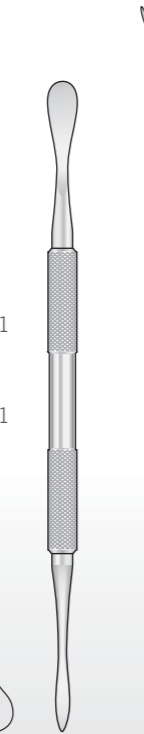

MOLT
718-M9
170 mm

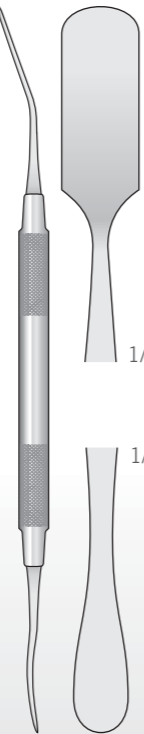

PRICHARD
718-PR3
180 mm



Fig. 24G
718-24G
175 mm

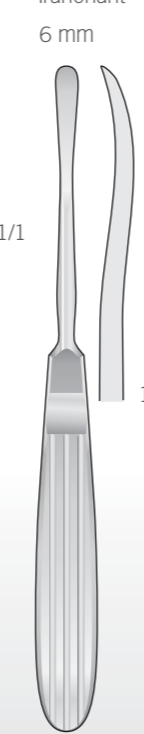

OBWEGESER
DO-59
175 mm



WILLIGER
WG-12
160 mm

Scharf
Sharp
Tagliente
Cortante
Tranchant

6 mm

Scharf
Sharp
Tagliente
Cortante
Tranchant

6 mm

Fig. 1		Fig. 2		Fig. 3		Fig. 4		Fig. 5	
Alt.	Diam.	Alt.	Diam.	Alt.	Diam.	Alt.	Diam.	Alt.	Diam.
0	Ø 1,50	0	Ø 2,10	0	Ø 2,60	0	Ø 3,00	0	Ø 3,50
5	Ø 1,90	5	Ø 2,60	5	Ø 3,00	5	Ø 3,50	5	Ø 3,90
8	Ø 2,20	8	Ø 2,80	8	Ø 3,30	8	Ø 3,80	8	Ø 4,20
10	Ø 2,40	10	Ø 3,00	10	Ø 3,50	10	Ø 4,00	10	Ø 4,40
12	Ø 2,60	12	Ø 3,20	12	Ø 3,70	12	Ø 4,20	12	Ø 4,60
14	Ø 2,80	14	Ø 3,40	14	Ø 3,90	14	Ø 4,40	14	Ø 4,80

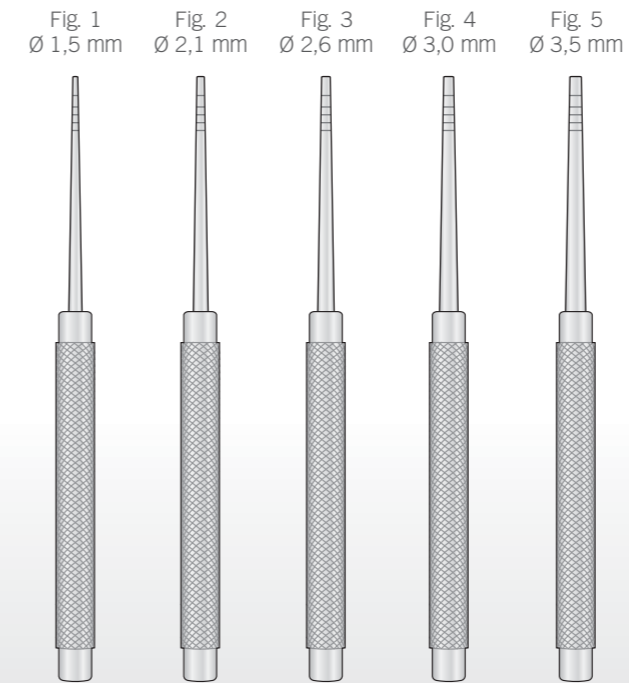

FL-292 155 mm FL-293 155 mm FL-294 155 mm FL-295 155 mm FL-296 155 mm FL-297 155 mm FL-298 155 mm FL-299 155 mm FL-25 145 mm FL-26 145 mm FL-27 145 mm

Retificatori
Rettificatori

Osteotom A-Form
Implant Site Dilators
Dilatatori per osso
Dilatadores oséos
Dilatateur d'os

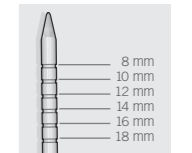

Ø 2 mm Ø 2,7 mm Ø 3,25 mm

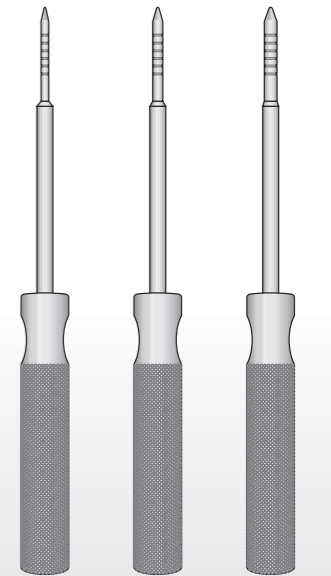



Implantologie
 Implantology
 Implantologia
 Implantologia
 Implantologie

Osteotom D-Form
 Expansion Osteotomes
 Espansori di osso
 Expansores oséos
 Expansors d'os

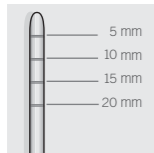

Osteotome
 Osteotomes
 Osteotomi
 Ostéotomos
 Ostéotomes

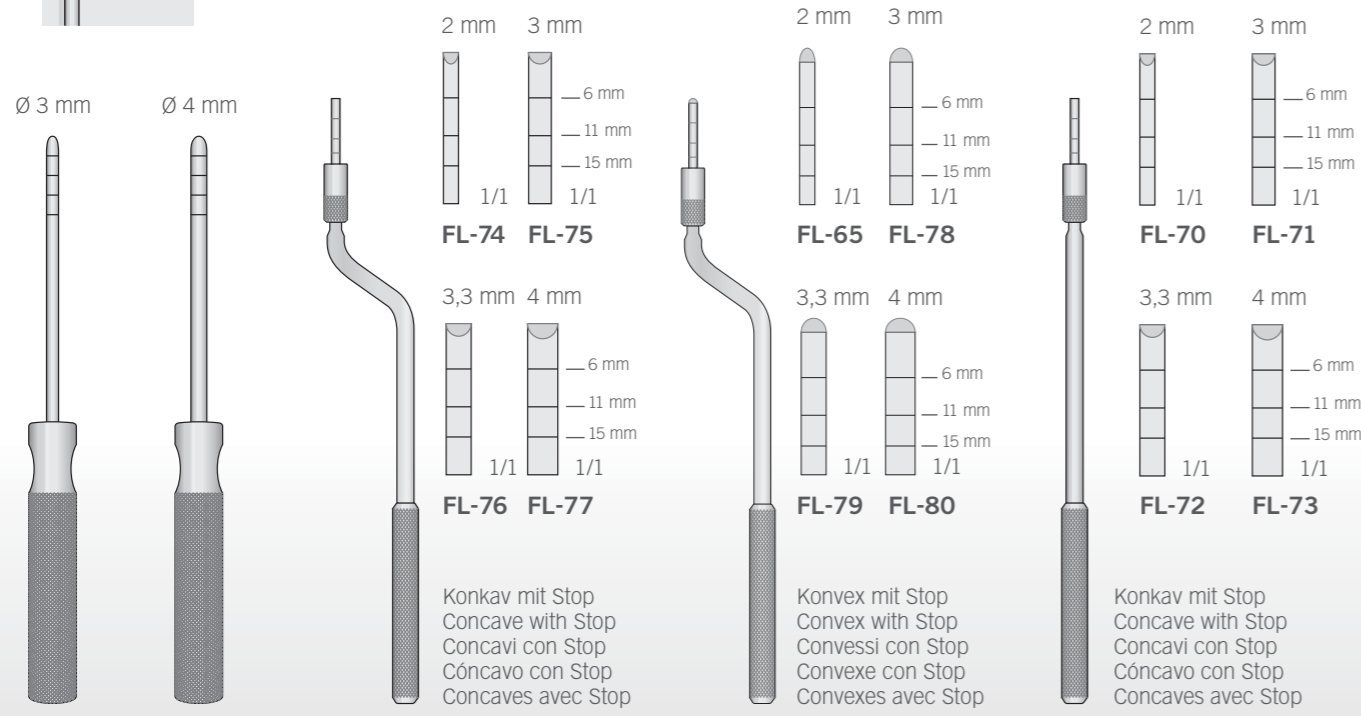

FL-37
145 mm

FL-38
145 mm

FL-74/FL-77
165 mm

FL-65/FL-80
160 mm

FL-70/FL-71
165 mm

Konkav mit Stop
 Concave with Stop
 Concavi con Stop
 Cóncavo con Stop
 Concaves avec Stop

Konvex mit Stop
 Convex with Stop
 Convessi con Stop
 Convexe con Stop
 Convexes avec Stop

Konkav mit Stop
 Concave with Stop
 Concavi con Stop
 Cóncavo con Stop
 Concaves avec Stop

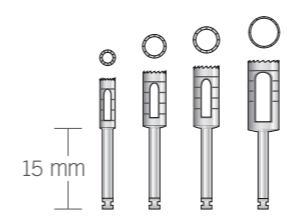

Dentalschaft
Dental Attack
Attacco Dental

GA-33 Ø est. 3,0 mm Ø int. 2,5 mm
GA-34 Ø est. 4,5 mm Ø int. 4,0 mm
GA-35 Ø est. 5,0 mm Ø int. 4,5 mm
GA-36 Ø est. 6,0 mm Ø int. 5,5 mm

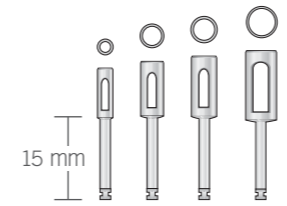

Zirkuliersmesser - Circular knife
Mucotomi, Bisturi circolari
Cuchillo circular - Couteau circulaire

GA-63 Ø est. 3,0 mm Ø int. 2,5 mm
GA-64 Ø est. 4,5 mm Ø int. 4,0 mm
GA-65 Ø est. 5,0 mm Ø int. 4,5 mm
GA-66 Ø est. 6,0 mm Ø int. 5,5 mm

Wundhaken - Hämmer - Trephine
 Retractors - Mallets - Trephines
 Divaricatori - Martelli - Frese carotatrici
 Separadores - Martillos - Trephine
 Ecarteurs - Maillets - Trephine



OM-85
 Komplettsset mit 3 Spatel
 Set complete with 3 spatulas
 Set completo con 3 spatole
 Set completos con 3 espátulas
 Set complete avec 3 spatules

OM-80 + OM-81 + OM-82

Rostfrei - Stainless Steel
 Acciaio - Acero - Acer

Biegsam
 Malleable
 Malleabil
 Maleables
 Souples

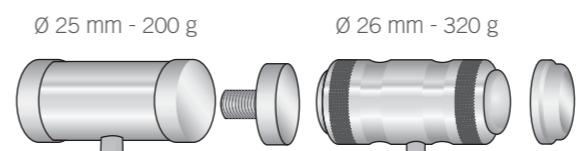

FL-11R

Paar Ersatzbacken
 Pair of spare faces
 Coppia di teste di ricambio
 Pareja de tapas intercambiables
 Paire de faces de rechange

Mit auswechselbaren Kunststoffbacken
 With interchangeable plastic disks
 Con punte e ricambi in teflon
 Con tapas de plástico reemplazables
 Avec embouts de plastique rechangeables

FL-12R

Paar Ersatzbacken
 Pair of spare faces
 Coppia di teste di ricambio
 Pareja de tapas intercambiables
 Paire de faces de rechange

Mit auswechselbaren Kunststoffbacken
 With interchangeable plastic disks
 Con punte e ricambi in teflon
 Con tapas de plástico reemplazables
 Avec embouts de plastique rechangeables

22 mm

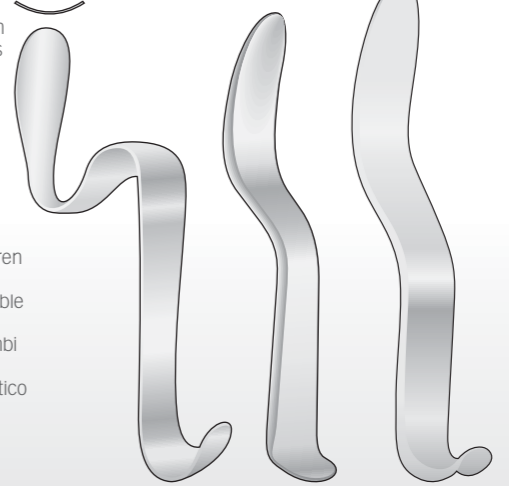

BISHOP
OM-61
130 mm

MINNESOTA
OM-55
140 mm

CAWOOD
MINNESOTA
OM-66
160 mm

OM-80
200 mm

OM-81
200 mm

OM-82
240 mm

MEAD
FL-11
200 mm

MEAD
FL-12
190 mm



Applicationsinstrument
 für Knochen-Material
 Graft materials Syringes
 Inserters for Bone material
 Siringhe per biomateriali

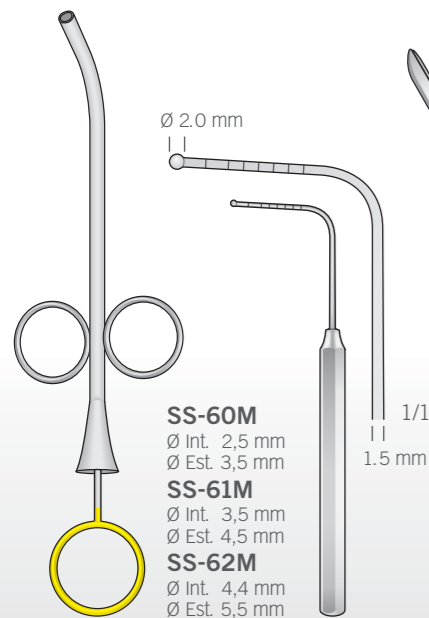

SS-60M
 Ø Int. 2,5 mm
 Ø Est. 3,5 mm
SS-61M
 Ø Int. 3,5 mm
 Ø Est. 4,5 mm
SS-62M
 Ø Int. 4,4 mm
 Ø Est. 5,5 mm

GA-78

Knochen-Schaben
 Komplett mit Reibeschlinge
 Bone-Grafts complete
 with blade
 Grattino completo di lama

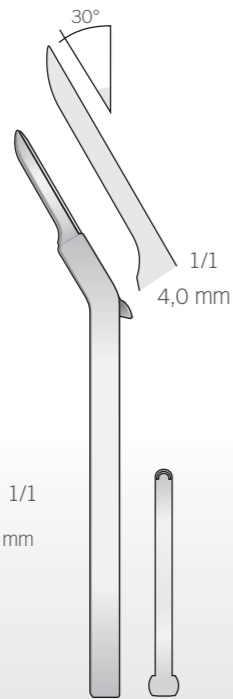

GA-60
100 mm

GA-78
155 mm

GA-79
60 mm

GA-78 GA-79
150 mm

SS-65
35 mm

GF-11

Set komplett mit Griff + 4 Kanülen
 Set complete with handle + 4 tubes
 Set completo di manico + 4 cannule
 Set completo con mango + 4 canulas
 Set complet avec poignée + 4 canules

Ø 1 mm Ø 1,5 mm Ø 2,5 mm Ø 3,5 mm

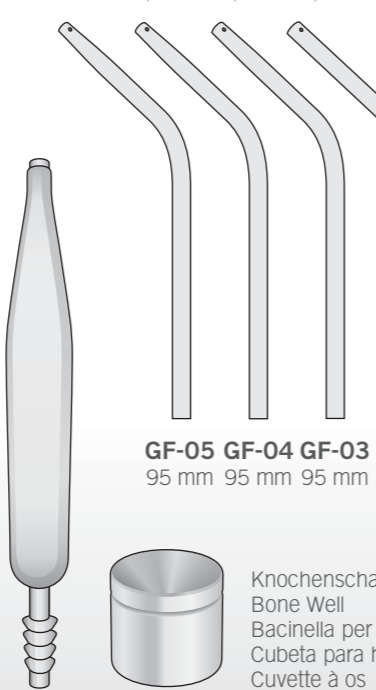

GF-05 GF-04 GF-03 GF-02
 95 mm 95 mm 95 mm 95 mm

GF-134
20 mm

Absaugkanülen für Knochen
 Suction tube for bone
 Cannule d'aspiration con trattenuta osso
 Canulas aspiradoras para hueso
 Canule à aspiration d'os

Ersatzknochenfilter
 Bone Filter of replacement
 Filtro di ricambio per osso
 Filtro de repuesto para hueso
 Filtre de rechange pour os

Rostfrei
 Stainless Steel
 Acciaio inossidabile
 Acero inoxidable
 Acier Inoxydable

Ø 10 mm int.

Mit 1 Filter
 With 1 filter
 Con 1 filtro
 Con 1 filtro
 Avec 1 filtre

GF-133
180 mm

Knochenschale
 Bone Well
 Bacinella per osso
 Cubeta para hueso
 Cuvette à os

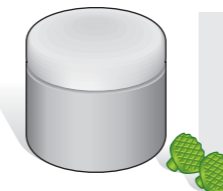

Powder adhesive
 Polvere adesiva
 10 gr.

DP-136

Set consisting of 1 ea. Crown-tractor
 and 10 Plastic-Polymer tips, and 10g. Powder Adhesive
 Set completo di pinza per corone,
 10 coppie di inserti in plastica e 10 gr. di polvere adesiva

DP-137

Replacement Kit Consisting of 10 couples
 Plastic-Polymer Tips and 10 g. Powder Adhesive
 Kit di ricambio con 10 coppie di inserti
 in plastica e 10 gr. di polvere adesiva

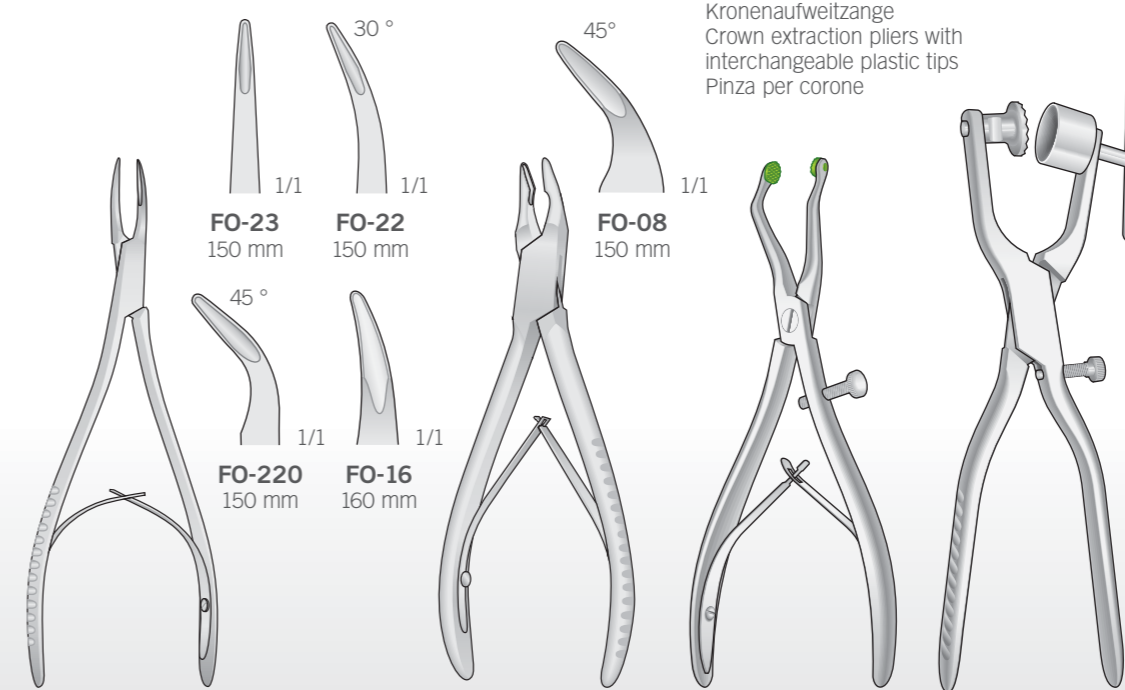

FO-16/FO-220

FO-08
150 mm

DP-136
140 mm

GA-20



GA-17
 Titan-Mahlwerk
 Upper Titanium Milling part
 Inserto superiore in titanio



GA-18
 Titan-Mahlwerk
 Lower Titanium Milling part
 Inserto inferiore in titanio



GA-19
 Griffe
 Handle
 Manico



GA-19A
 Schrauben
 Screw
 Vite

Knochenmahlzange
 Bone Mill Forceps
 Pinza macina osso
 Molino de hueso
 Broyeur d'os



Meissel - Löffel
Chisels - Curettes
Scalpelli - Cucchiali
Cinceles - Cucharillas
Burins - Curettes

Instrumente für Parodontologie
Periodontal Instruments
Strumenti per Parodontologia
Instrumentos para la cirugía periodontal
Instruments de chirurgie



Runder Hohlgriff 8 mm
Hollow Round Handle 8 mm
Manico tondo vuoto 8 mm
Mango hueco 8 mm
Manche rond vide 8 mm

Knochenmeißel Graduiert
Graduated Chisels
Scalpelli graduati
Osteótomos graduado
Ostéotomes gradués

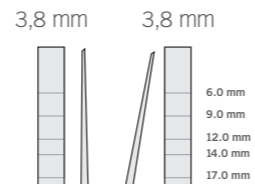

FL-141 170 mm
FL-142 170 mm

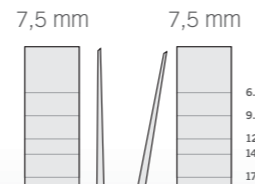

FL-143 170 mm
FL-144 170 mm

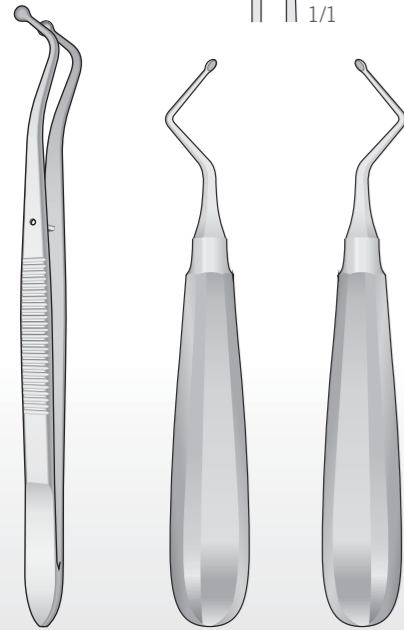

MIR-10
160 mm

KERPEL
FK-138
145 mm

KERPEL
FK-139
145 mm

HEMINGWAY
720-101/720-104
180 mm

LUCAS
720-85/720-88
180 mm

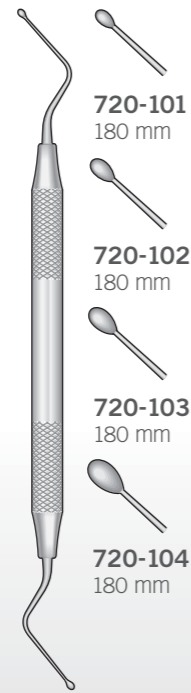

720-101
180 mm

720-102
180 mm

720-103
180 mm

720-104
180 mm

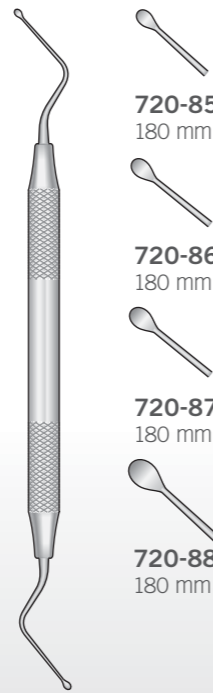

720-85
180 mm

720-86
180 mm

720-87
180 mm

720-88
180 mm



FL-141/FL-144
170 mm

Fig. 1



FEDI
OF-1
175 mm



RHODES BACK
ACTION
718-107



KIRKLAND
718-123
Fig. 15K/16K

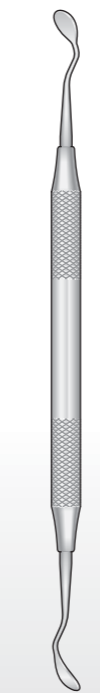

718-147
Fig. 7

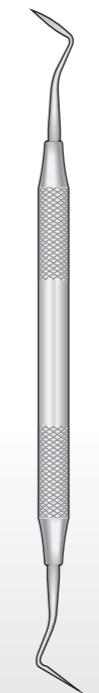

718-151
Fig. 11



EN-M1
160 mm



EN-M3
180 mm



EN-M4
170 mm



EN-M5
175 mm



718-EN1
175 mm

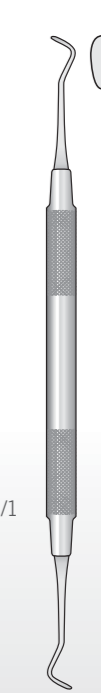

718-EN2
165 mm

Skalpelle - Scalpel
Bisturi - Bisturi
Bistouris

GOLDMAN-FOX



Arterienklemmen
Hemostatic Forceps
Pinze emostatische
Pinzas hemostáticas
Pincas hémostatiques

**NEW
MODELS**



Kleinsetcontainer / Mini Container

Sterilization Container
Sterilization Containers
Contenitori per sterilizzare
Contenedores para esterilización
Containers pour stériliser

CT-555N
CT-556N
CT-557N
CT-558N
CT-559N

CT-560N
CT-561N
CT-562N
CT-563N
CT-564N

CT-565N
CT-566N
CT-567N
CT-568N
CT-569N

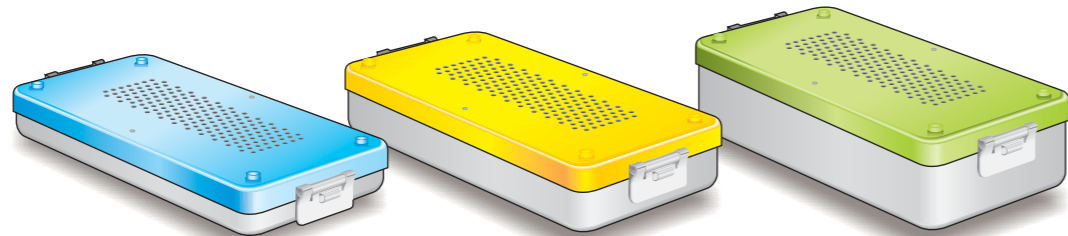

CT-555N/CT-556N

Outside 300 x 140 x 40 mm
Inside 280 x 130 x 27 mm

CT-560N/CT-564N

Outside 300 x 140 x 70 mm
Inside 280 x 130 x 55 mm

CT-565N/CT-569N

Outside 300 x 140 x 100 mm
Inside 280 x 130 x 84 mm

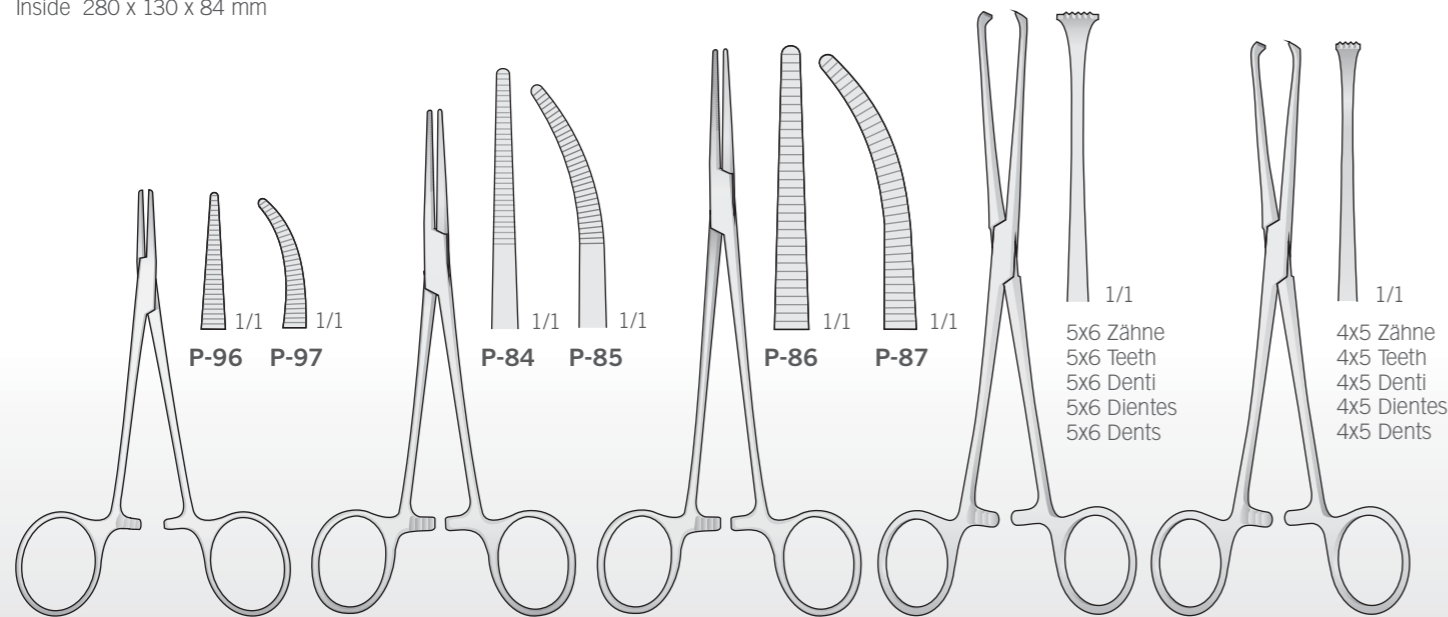

HALSTED-MOSQUITO
P-96/P-97
120 mm

KELLY
P-84/P-85
140 mm

CRILE
P-86/P-87
160 mm

ALLIS
P-50
160 mm

BABY-ALLIS
P-100
130 mm

Atraumatic Extraction Facilitator

Luxating Elevator with Exact Tips

MIR-27SET

Set of 7 Luxating Elevators with Exact Tips

With Stainless Steel Cassette

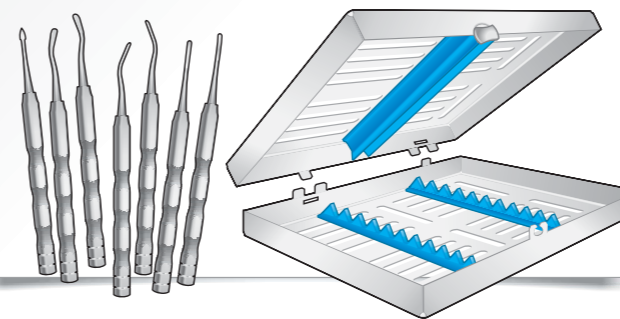

Angled IN Angled OUT Angled IN Angled OUT

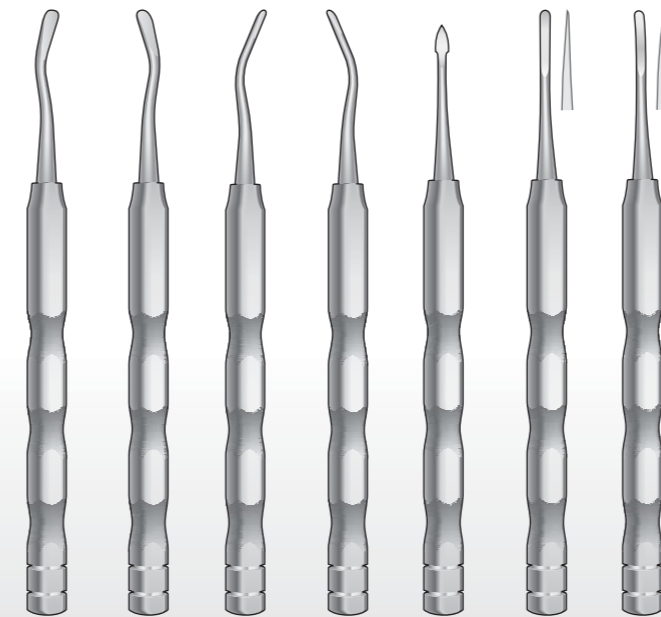

Large MIR-20 160 mm Large MIR-24 160 mm Small MIR-23 160 mm Small MIR-21 160 mm Bayonet MIR-25 160 mm Straight MIR-22 160 mm Curved MIR-26 160 mm

MIR-34 Set
MIR-30 - MIR-31 - MIR-32 - MIR-33

Distraktoren für Knochenleiste
Bone expander
Distrattori per cresta ossea
Distractores de la cresta ósea
Distracteurs de crête osseuse

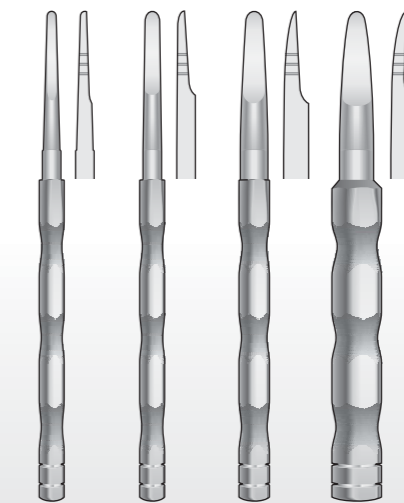

MIR-30 130 mm MIR-31 130 mm MIR-32 130 mm MIR-33 130 mm

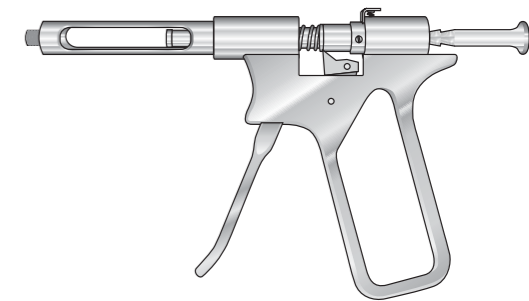

Aufzüge - Spritzen
Elevators - Syringes
Elevatori - Siringhe
Elevadores - Jeringas
Elevateurs - Seringues

**PERIPRESS
SD-7**

Zylinder-Ampullen Spritzen
Cartridge Syringes
Siringhe per tubofiale
Jeringas de ampollas
Seringues d'ampoules

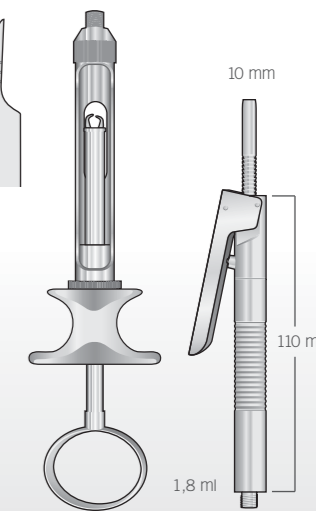

SD-3 SD-20



Separierzange, zum Einbringen von Gummi-Separierligaturen
Separating forceps, for inserting elastic separators
Pinze per legature per separatori elastici
Pinza para ligaduras estira elásticos
Pince à serrer les ligatures

Bracketset Pinzette
Forceps for positioning brackets
Pinzette per riposizionare gli attacchi diretti
Pinza para colocar Brackets
Précelle pour positionner les brackets

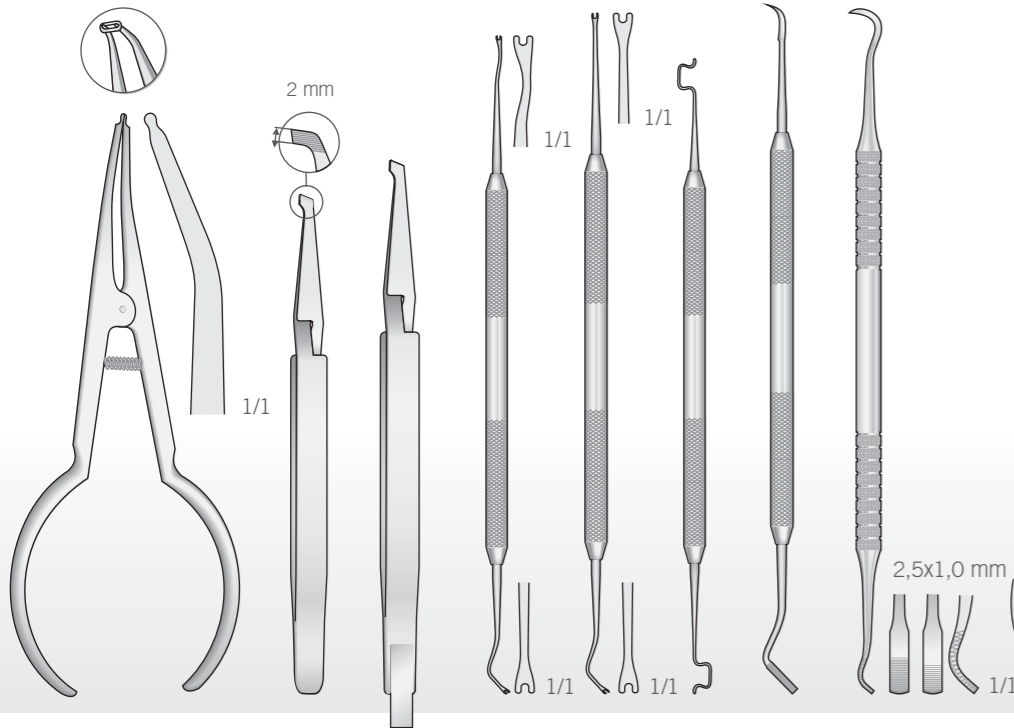

DF-20 155 mm
DP-127 125 mm
DP-128 145 mm
PF-1 170 mm
PF-2 160 mm
PF-3 160 mm
DP-54 175 mm
SHURE DP-124 175 mm

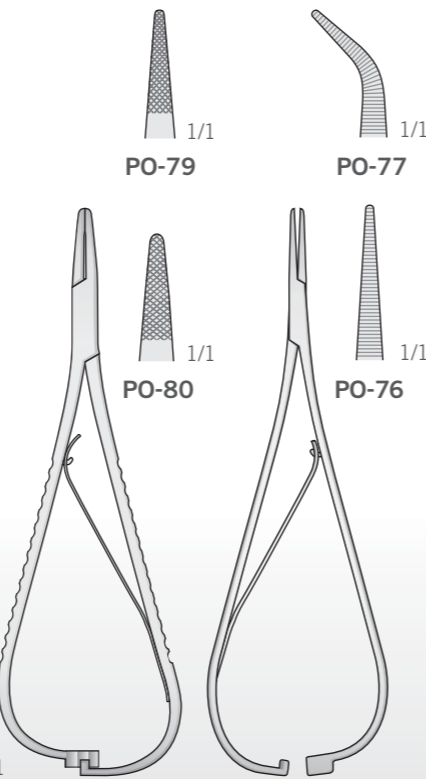

MATHIEU PO-79/PO-80 140 mm
SMAHA PO-76/PO-77 140 mm

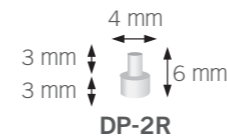

DP-2R

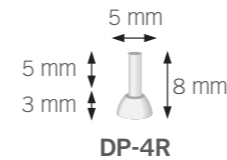

DP-4R

Für weichen und harten Draht
For soft and hard Wire
Per filo leggero e duro
Para alambre blando y duro
Pour fil léger e dur

○ Max Ø 0.7 mm (.028")

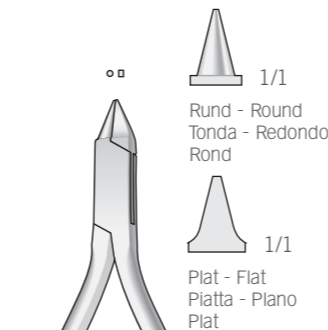

ANGLE DP-01 125 mm

Ersatz-Plastikschutzkappen für:
Replacements plastic tips for:
Punte di ricambio in teflon per:
Puntas de recambio de plástico para:
Pointes plastiques interchangeables pour:
DP-36T

Ersatz-Plastikschutzkappen für:
Replacements Plastic tips for:
Punte di ricambio in teflon per:
Puntas de recambio de plástico para:
Pointes plastiques interchangeables pour:
DP-36T

Bandabnehmerzange
Band remover
Pinza per rimuovere le bande
Alicates para quitar bandas
Pinces à détacher les bagues

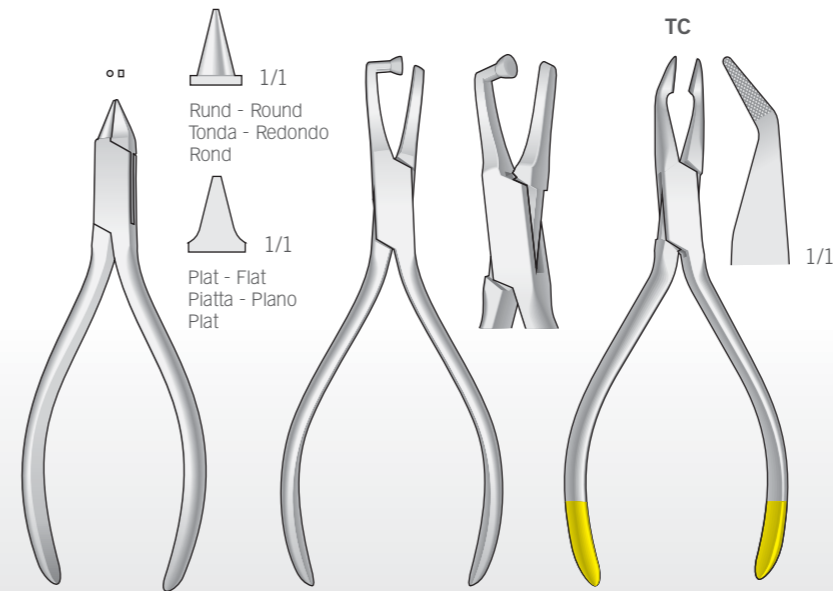

ADERER DP-36T 135 mm
WEINGART DP-135 140 mm
LX-89 120 mm

Mit Hartmetalleinsätzen
With hard metal inserts
Con punte in metallo duro
Con puntas de metal duro
Avec mors en métal dur

Für weichen und harten Draht
For soft and hard Wire
Per fili duri, grossi e intrecciati
Para alambre blando y duro
Pour fil léger e dur

○ Max Ø 0.7 mm (.028")

□ 0.56 x 0.71 mm (.022" x .028")

⊗ 0.53 x 0.64 mm (.021" x .025")

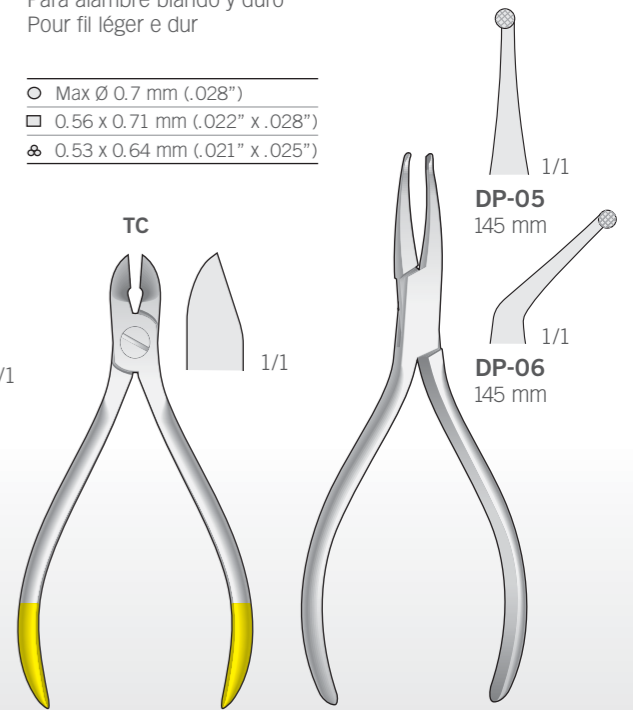

DP-05 145 mm
DP-06 145 mm

Universalzange für die Multibandtechnik
Universal forceps for Multiband Technique
Pinze di utilità per archi
Alicates para formar bandas
Pinces à former les rubans



Kieferorthopädie
Orthodontics
Ortodonzia
Ortodoncia
Orthodontie

Mit Hartmetalleinsätzen
With hard metal inserts
Con punte in metallo duro
Con puntas de metal duro
Avec mors en métal dur

Distal-Schneider mit
Drahtfangvorrichtung
Distal Cutter with wire holding device
Tronchese distale con trattenuta del filo
Alicates de corte distal con dispositivo
retenedor del alambre
Pinces à couper distale avec
dispositif de rétention

- Max Ø 0.5 mm (.020")
- 0.41 x 0.56 mm (.016" x .022")
- ⊗ Max Ø 0.4 mm (.0155")

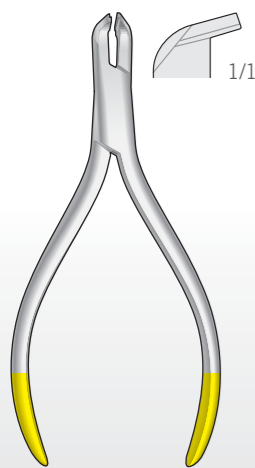

LX-DS1
125 mm

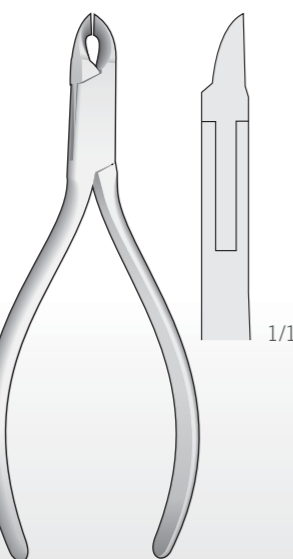

ANGLE
LX-95
130 mm

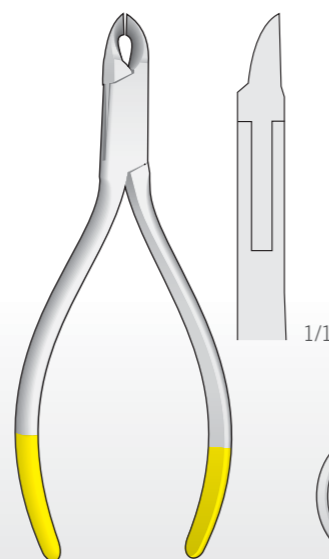

ANGLE
LX-95TC
130 mm



BEEBE
DP-91/DP-105
110 mm

Für weichen und harten Draht
For soft and hard Wire
Per fili sottili e morbidi
Para alambre blando y duro
Pour fil léger e dur

Ligaturen Schneidezange
Ligature Cutters
Solo per rimuovere le legature
Alicates para cortar ligaduras
Pinces à sectionner les ligatures

Ligaturen Schneidezange
Ligature Cutters
Solo per rimuovere le legature
Alicates para cortar ligaduras
Pinces à sectionner les ligatures

- Max Ø 0.3 mm (.012")

- Max Ø 0.4 mm (.016")

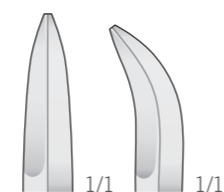

DP-102 DP-105

Stumpf - Blunt - Smusse
Romas - Mousse

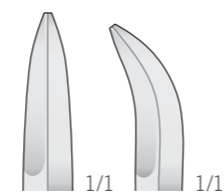

DP-91 DP-92

Spitz - Sharp - Acuta
Aguda - Pointu

*La BONTEMPI opera da quasi 40 anni
nella produzione di strumentario chirurgico,
realizzato con i migliori acciai Tedeschi.
Attualmente siamo presenti nei principali mercati esteri,
con una produzione d'assoluta avanguardia
ed un severo controllo di qualità.
La nostra produzione di strumentario
comprende tutte le linee della Chirurgia
(Odontoiatria, Implantologia, Parodontologia,
Ortodonzia, Maxillo-Facciale, Chirurgia estetica,
Chirurgia plastica, Veterinaria
e tutti i settori della Chirurgia Generale e Ospedaliera).
La qualità superiore dei nostri strumenti
risiede nelle speciali leghe di acciaio martensitico
di cui sono composti, che,
associata ad un ottimo rapporto qualità/prezzo,
riscontra continui consensi ed approvazioni in tutti i mercati.*

BONTEMPI®



www.medicalway.it

Medical Way di Roberto Spano
Via Scandolara, 58/A - 31059 Zero Branco (TV) - Tel. 0422 488087 - Fax 0422 488748
medicalway14@gmail.com